

# SEÑALIZACIÓN

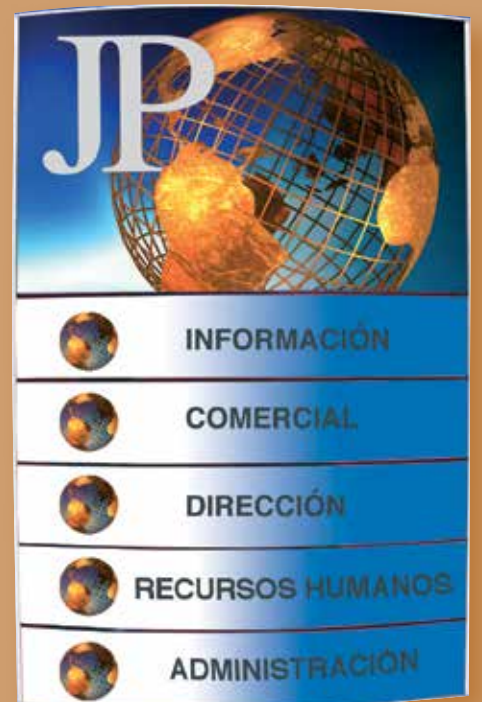

# FRENTE CURVO

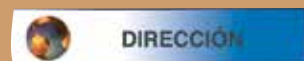
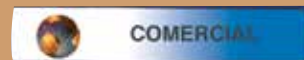
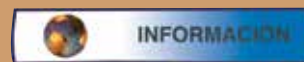

**REFERENCIA**  
JRV  
40 mm

**REFERENCIA**  
TDCA  
20X30 mm

**REFERENCIA**  
T40X100  
40x100 mm

LONGITUD DE LAS BARRAS 4,30 m.

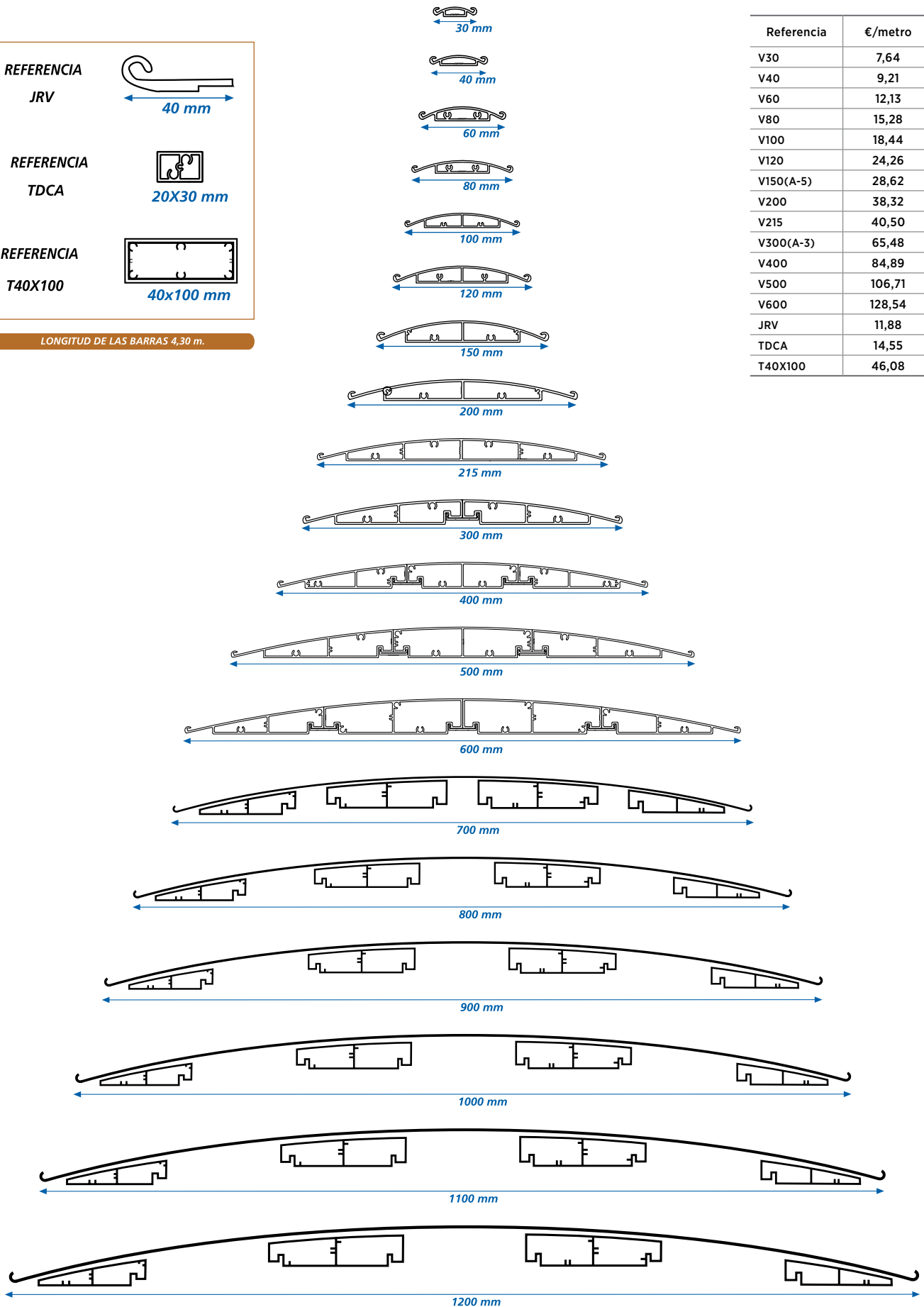

Referencia	€/metro
V30	7,64
V40	9,21
V60	12,13
V80	15,28
V100	18,44
V120	24,26
V150(A-5)	28,62
V200	38,32
V215	40,50
V300(A-3)	65,48
V400	84,89
V500	106,71
V600	128,54
JRV	11,88
TDCA	14,55
T40X100	46,08

## PLÁSTICO FRONTAL



Referencia	Para Lama	Espesor	€/metro
PLFV30	V30	0,25	3,39
PLFV40	V40	0,25	4,24
PLFV60	V60	0,50	5,10
PLFV80	V80	0,50	5,94
PLFV100	V100	1	6,79
PLFV120	V120	1	7,28
PLFV150	V150(A-5)	1	7,77
PLFV200	V200	1	8,49
PLFV215	V215(A-4)	1	9,21
PLFV300	V300(A-3)	1,5	23,28
PLFV400	V400	2	24,26
PLFV500	V500	2	29,11
PLFV600	V600	2	33,96

## TAPAS DE PLÁSTICO



Referencia	Para Lama	Color	€/unidad
TAPV30GR / TAPV30NE	V30	GRIS / NEGRO	0,60
TAPV40GR / TAPV40NE	V40	GRIS / NEGRO	0,78
TAPV60GR / TAPV60NE	V60	GRIS / NEGRO	1,17
TAPV80GR / TAPV80NE	V80	GRIS / NEGRO	1,93
TAPV100G / TAPV100N	V100	GRIS / NEGRO	2,00
TAPV120G / TAPV120N	V120	GRIS / NEGRO	2,35
TAPV150G / TAPV150N	V150(A-5)	GRIS / NEGRO	2,60
TAPV200G / TAPV200N	V200	GRIS / NEGRO	2,60
TAPV215G / TAPV215N	V215(A-4)	GRIS / NEGRO	2,91
TAPV300G / TAPV300N	V300(A-3)	GRIS / NEGRO	4,85

## TAPAS DE ALUMINIO



Referencia	Para Lama	Color	€/unidad
TAAV60G	V60	GRIS	7,19
TAAV80G	V80	GRIS	7,81
TAAV100G	V100	GRIS	7,92
TAAV120G	V120	GRIS	8,28
TAAV150G	V150(A-5)	GRIS	11,23
TAAV200G	V200	GRIS	13,10
TAAV215G	V215(A-4)	GRIS	17,28
TAAV300G	V300(A-3)	GRIS	18,35
TAAV400G	V400	GRIS	19,00
TAAV500G	V500	GRIS	19,20
TAAV600G	V600	GRIS	20,62
TAAV700G	V700	GRIS	42,41
TAAV800G	V800	GRIS	47,29
TAAV900G	V900	GRIS	52,65
TAAV1000G	V1000	GRIS	62,07
TAAV1100G	V1100	GRIS	69,48
TAAV1200G	V1200	GRIS	73,46

## TORNILLOS | VENTOSAS | TIRAS SEPARADORAS



Referencia	Artículo	€/unidad
TTA	TORNILLO PARA TAPA METÁLICA/PLÁSTICA	0,07
TBMP	TORNILLO PARA BASE METÁLICA PEQUEÑO	0,10
TBMM	TORNILLO PARA BASE METÁLICA MEDIANO	0,12
TBMG	TORNILLO PARA BASE METÁLICA GRANDE	0,15
TBMVL	TORNILLO PARA BASE METÁLICA MONOLITO CON LUZ	0,22

Referencia	Artículo	€/unidad
VE	VENTOSAS	1,25

Referencia	Color	€/unidad
TSA	AMARILLA	0,85
TSAZ	AZUL	
TSB	BLANCA	
TSR	ROJA	

## CONECTOR DE TECHO DOBLE CARA

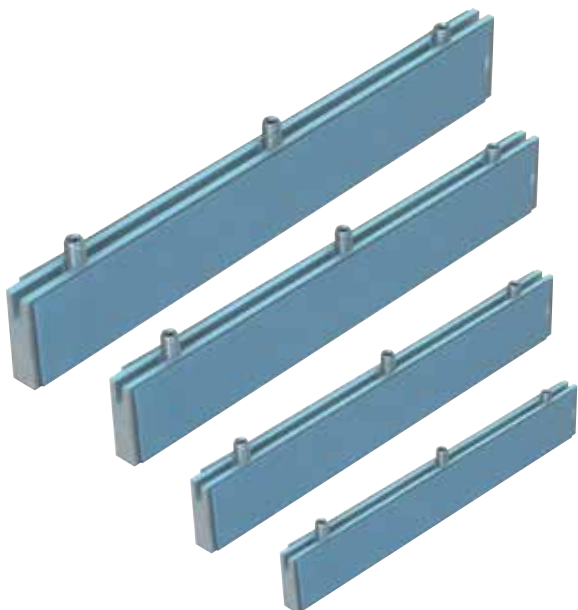

Referencia	Para lama	€/unidad
CTDCV60	V60	7,30
CTDCV80	V80	10,96
CTDCV100	V100	11,04
CTDCV120	V120	11,26
CTDCV150	V150(A-5)	12,81
CTDCV200	V200	13,96
CTDCV300	V300(A-3)	14,03
CTDCV400	V400	15,56
CTDCV500	V500	16,48
CTDCV600	V600	18,30

## CABLE TRENZADO Y PRISIONEROS



Referencia	Artículo	Precio
CATRE	CABLE TRENZADO PARA CONECTOR DE TECHO	2,96 €/metro
PRI	PRISIONERO PARA CABLE TRENZADO	0,98 €/unidad



## TAPA METÁLICA



Referencia	Para Lama	€/unidad
TADCEV100	V100	9,06
TADCEV120	V120	10,00
TADCEV150	V150(A-5)	12,11
TADCEV200	V200	15,81
TADCEV215	V215(A-4)	17,48
TADCEV300	V300(A-3)	22,11
TADCEV400	V400	36,78
TADCEV500	V500	39,63
TADCEV600	V600	44,07

## BASE - ANCLAJE



Referencia	Para Lama	€/unidad
BDCEV215	V215(A-4)	53,26
BDCEV300	V300(A-3)	63,19
BDCEV400	V400	89,14
BDCEV500	V500	106,37
BDCEV600	V600	113,70

## BASE - LIBRE

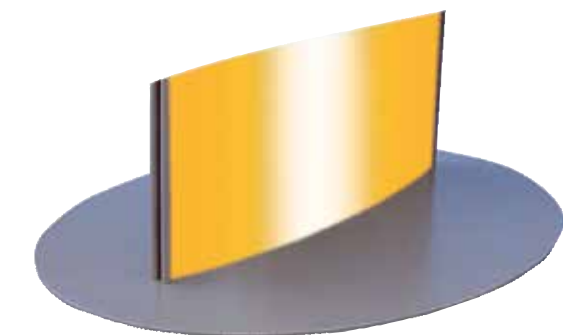

Referencia	Para Lama	€/unidad
BLE2150	V150(A-5)	17,67
BLE2200	V200	18,56
BLE2215	V215(A-4)	21,44
BLE2300	V300(A-3)	37,26
BLE2400	V400	59,22
BLE2500	V500	85,11
BLE2600	V600	113,85

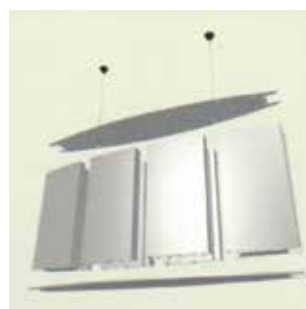
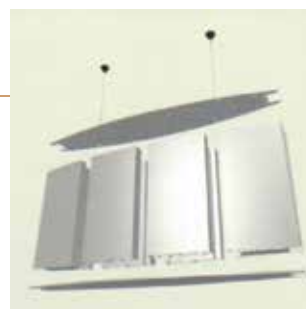

## TAPA METÁLICA

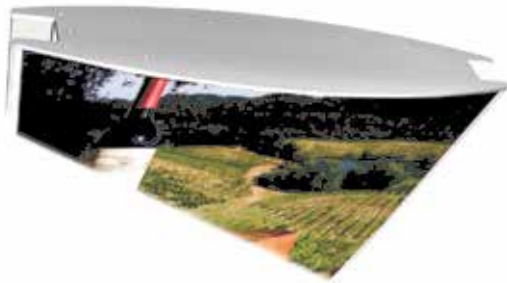

Referencia	Para Lama	€/unidad
TADCAV200	V200	18,00
TADCAV215	V215(A-4)	18,21
TADCAV300	V300(A-3)	23,48
TADCAV400	V400	38,30
TADCAV500	V500	49,33
TADCAV600	V600	60,41
TADCAV700	V700	102,30
TADCAV800	V800	113,60
TADCAV900	V900	137,15
TADCAV1000	V1000	141,30
TADCAV1100	V1100	150,04
TADCAV1200	V1200	165,93

## BASE - ANCLAJE



Referencia	Para Lama	€/unidad
BDCAV200	V200	55,48
BDCAV215	V215(A-4)	63,33
BDCAV300	V300(A-3)	79,26
BDCAV400	V400	109,67
BDCAV500	V500	117,96
BDCAV600	V600	122,74
BDCAV700	V700	137,56
BDCAV800	V800	188,04
BDCAV900	V900	221,63
BDCAV1000	V1000	255,18
BDCAV1100	V1100	287,26
BDCAV1200	V1200	320,85

## BASE - LIBRE



Referencia	Para Lama	€/unidad
BLA2150	V 150 (A-5)	18,63
BLA2200	V 200	22,78
BLA2215	V 215 (A-4)	27,55
BLA2300	V 300 (A-3)	42,63
BLA2400	V 400	70,77
BLA2500	V 500	87,52
BLA2600	V 600	92,44
BLA2700	V 700	139,07
BLA2800	V 800	158,33
BLA2900	V 900	179,48
BLA21000	V 1000	325,77
BLA21100	V 1100	383,85
BLA21200	V 1200	497,56

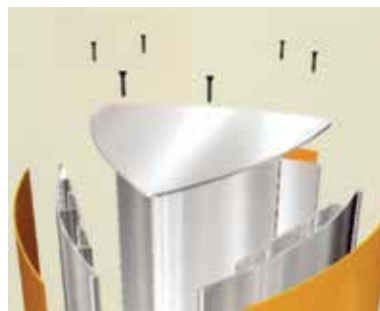

## TAPA METÁLICA TRES CARAS



Referencia	Para Lama	€/unidad
TM3150	V150(A-5)	24,04
TM3200	V200	29,00
TM3215	V215(A-4)	30,63
TM3300	V300(A-3)	44,59
TM3400	V400	76,81
TM3500	V500	91,59
TM3600	V600	143,11

## BASE - ANCLAJE TRES CARAS



Referencia	Para Lama	€/unidad
BA3150	V150(A-5)	33,52
BA3200	V200	43,89
BA3215	V215(A-4)	60,59
BA3300	V300(A-3)	106,74
BA3400	V400	206,44
BA3500	V500	276,18
BA3600	V600	408,74

## BASE - LIBRE TRES CARAS



Referencia	Para Lama	€/unidad
BL3150	V150(A-5)	37,25
BL3200	V200	48,30
BL3215	V215(A-4)	58,33
BL3300	V300(A-3)	108,04
BL3400	V400	180,96
BL3500	V500	205,96
BL3600	V600	333,85

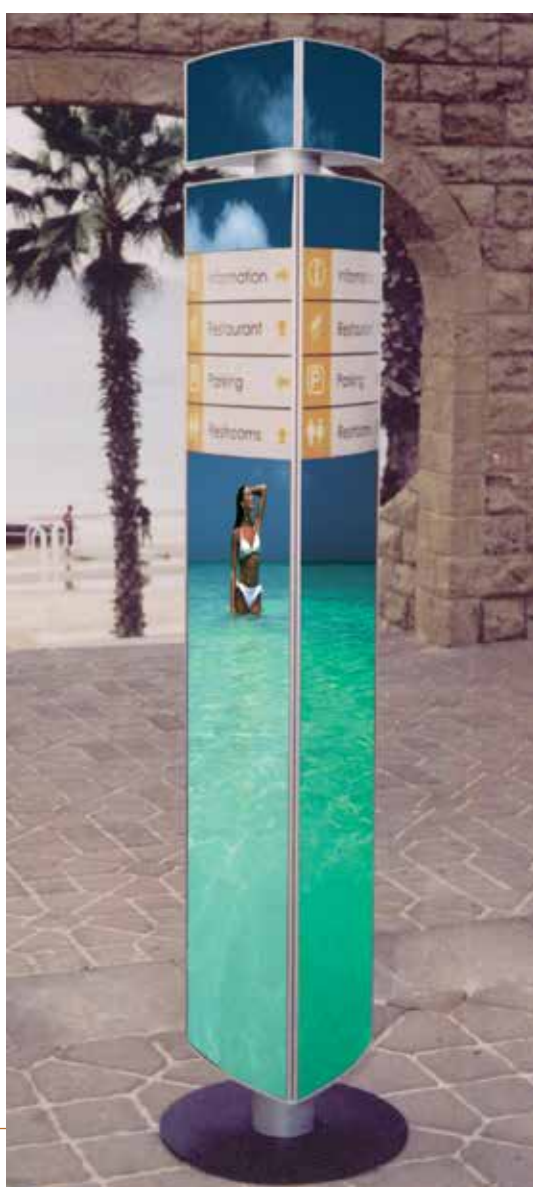
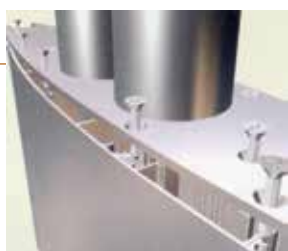

## PERFIL POSTE

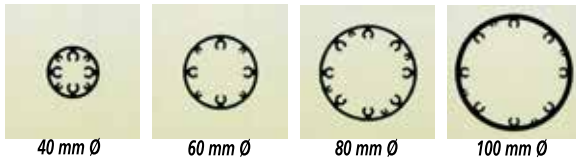

Referencia	Ø mm.	€/metro
PP40	40	17,00
PP60	60	62,77
PP80	80	78,67
PP100	100	82,24

## BASE - ANCLAJE CON POSTE



Referencia	Para poste	€/unidad
BAP40	Ø 40 mm	25,15
BAP60	Ø 60 mm	28,42
BAP80	Ø 80 mm	30,33
BAP100	Ø 100 mm	32,73

## BASE - LIBRE CON POSTE



Referencia	Para poste	€/unidad
BLP40	Ø 40 mm	45,19
BLP60	Ø 60 mm	48,67
BLP80	Ø 80 mm	75,04
BLP100	Ø 100 mm	81,19

## TAPA METÁLICA PARA POSTE



Referencia	Para poste	€/unidad
TMP40	Ø 40 mm	12,33
TMP60	Ø 60 mm	13,01
TMP80	Ø 80 mm	14,19
TMP100	Ø 100 mm	15,30

## TAPA METÁLICA DOBLE CARA SISTEMA ANCHO CON POSTE



Referencia	Para Lama	Ø mm./ Poste	€/unidad
TMDCP200/40	V200	40	45,15
TMDCP215/40	V215(A-4)	40	67,15
TMDCP300/40	V300(A-3)	40	58,59
TMDCP300/60	V300(A-3)	60	58,59
TMDCP400/60	V400	60	72,25
TMDCP400/80	V400	80	73,30
TMDCP500/60	V500	60	88,41
TMDCP500/80	V500	80	99,96
TMDCP600/60	V600	60	125,70
TMDCP600/80	V600	80	136,63
TMDCP600/100	V600	100	142,33

## SOPORTE DE PARED (STANDARD)



Referencia	Para lama	€/unidad
SPSV100	V100	21,83
SPSV150	V150(A-5)	26,68
SPSV200	V200	31,53
SPSV300	V300(A-3)	36,39

## SOPORTE DE PARED (DELUXE)



Referencia	Para lama	€/unidad
SPDV100	V100	36,39
SPDV150	V150(A-5)	41,23
SPDV200	V200	48,50
SPDV300	V300(A-3)	75,19

**BASE DE SOBREMESA**



Referencia	Para lama	€/unidad
BS60	V60	10,11
BS80	V80	10,56
BS100	V100	10,93
BS120	V120	12,33
BS150	V150(A-5)	14,78
BS200	V200	18,44
BS215	V215(A-4)	18,44
BS300	V300(A-3)	25,15

**TAPA DE SOBREMESA**



Referencia	Para lama	Color	€/pareja
TASOV60NE / TASOV60PL	V60	NEGRO/ PLATA	21,83
TASOV80NE / TASOV80PL	V80	NEGRO/ PLATA	23,58
TASOV100NE / TASOV100PL	V100	NEGRO/ PLATA	24,88
TASOV120NE / TASOV120PL	V120	NEGRO/ PLATA	27,50
TASOV150NE / TASOV150PL	V150 (A-5)	NEGRO/ PLATA	34,94
TASOV200NE / TASOV200PL	V200	NEGRO/ PLATA	41,47
TASOV215NE / TASOV215PL	V215 (A-4)	NEGRO/ PLATA	45,85

**SOBREMESA DE TRES CARAS**

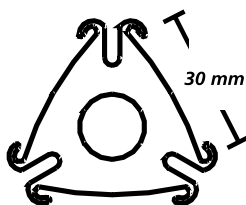

Referencia	Artículo	Precio
TS30	LAMA TS30	39,05 €/metro
PLFTS30	PLÁSTICO FRONTAL TS30	3,39 €/metro
TAPS30GR	TAPA PLÁSTICO TS30 GRIS	2,06 €/unidad
TAPS30NE	TAPA PLÁSTICO TS30 NEGRO	2,06 €/unidad

## MUESTRARIO GRANDE (21 RÓTULOS + CD + MANUAL)

ID	Descripción
1	• V 200 x 250 mm
2	• V 300 x 300 mm (con 5 separaciones)
3	• V 400 x 600 mm (con 11 separaciones)
4	• V 200 x 200 mm
5	• V 200 x 100 mm
6	• V 60 x 200 mm
7	• V 60 x 150 mm
8	• V 60 x 100 mm
9	• V 60 x 60 mm
10	• V 40 x 130 mm
11	• V 400 x 100 mm
12	• V 40 x 60 mm
13	• V 40 x 40 mm
14	• V 150 x 800 mm
15	• V 150 x 200 mm (con 5 separaciones)
16	• V 150 x 150 mm
17	• V 100 x 600 mm
18	• V 150 x 100 mm
19	• V 100 x 50 mm
20	• V 100 x 100 mm
21	• V 100 x 120 mm
22	• Ventosa
23	• Manual técnico
24	• Presentación Cd

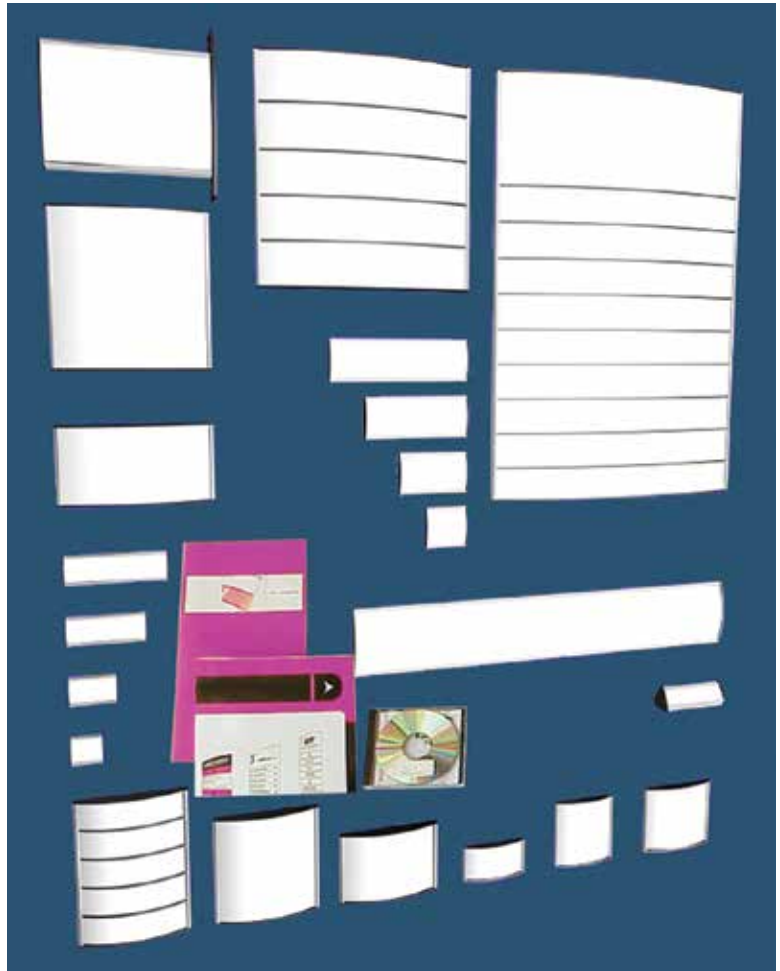

Referencia	€/unidad
MVG	533,57



# ERENTE PLANO

## LAMAS

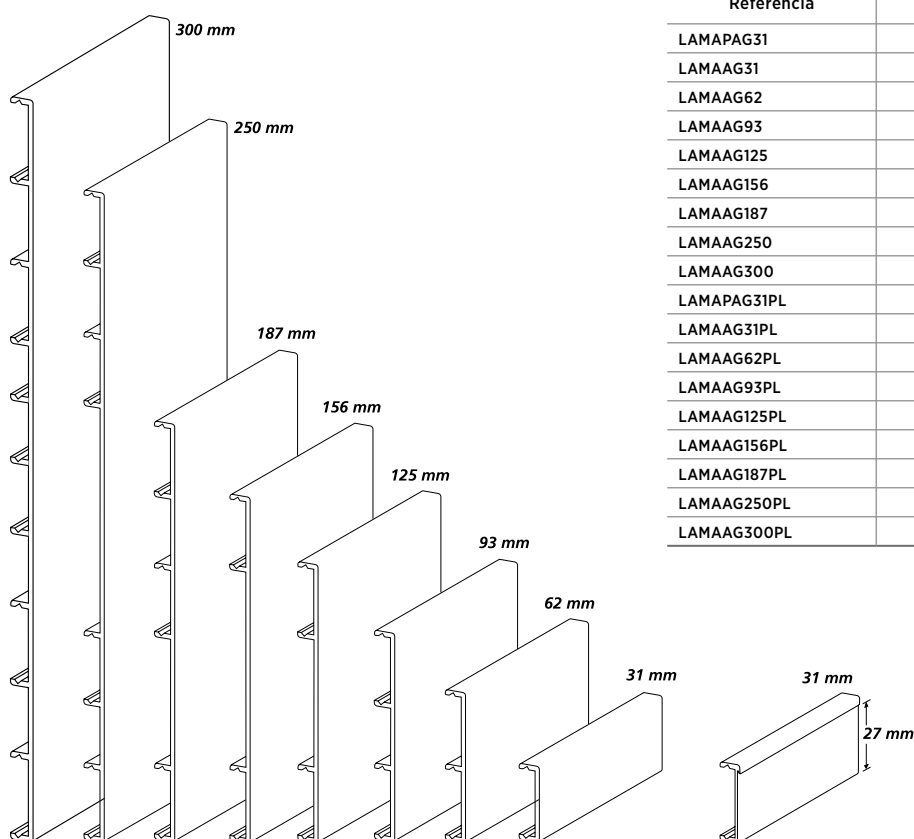

Referencia	Lama	Terminación	€/metro
LAMAPAG31	31-27 mm.	BRUTO	4,14
LAMAAG31	31 mm.	BRUTO	3,91
LAMAAG62	62 mm.	BRUTO	6,62
LAMAAG93	93 mm.	BRUTO	11,66
LAMAAG125	125 mm.	BRUTO	17,69
LAMAAG156	156 mm.	BRUTO	16,50
LAMAAG187	187 mm.	BRUTO	24,44
LAMAAG250	250 mm.	BRUTO	39,15
LAMAAG300	300 mm.	BRUTO	77,40
LAMAPAG31PL	31-27 mm.	ANODIZADO	5,55
LAMAAG31PL	31 mm.	ANODIZADO	5,15
LAMAAG62PL	62 mm.	ANODIZADO	9,70
LAMAAG93PL	93 mm.	ANODIZADO	14,65
LAMAAG125PL	125 mm.	ANODIZADO	20,86
LAMAAG156PL	156 mm.	ANODIZADO	24,82
LAMAAG187PL	187 mm.	ANODIZADO	31,60
LAMAAG250PL	250 mm.	ANODIZADO	48,74
LAMAAG300PL	300 mm.	ANODIZADO	84,81



## LAMAS DESLIZANTES

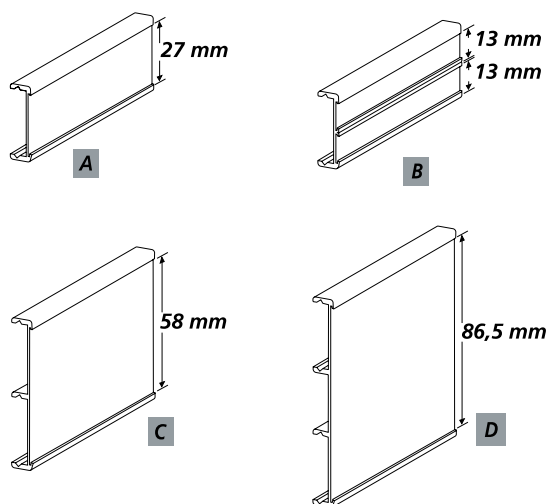

Referencia	Lama	Color	€/metro
LAMADAG31	31 mm.	BRUTO	4,02
LAMADAG312L	31 mm .2 líneas	BRUTO	3,41
LAMADAG62	62 mm.	BRUTO	6,50
LAMADAG93	93 mm.	BRUTO	9,89
LAMADAG31PL	31 mm.	ANODIZADO	5,55
LAMADAG312LPL	31 mm. 2 líneas	ANODIZADO	5,20
LAMADAG62PL	62 mm.	ANODIZADO	9,95
LAMADAG93PL	93 mm.	ANODIZADO	16,45

## PLÁSTICO PARA LAMAS DESLIZANTES



Referencia	Para lama de	Dimensiones mm.	€/metro
PLD31	31 mm.	1050 x 27	1,63
PLD62	62 mm.	1050 x 58	2,42
PLD93	93 mm.	1050 x 89	2,52

TAPA DE PLÁSTICO UNA CARA

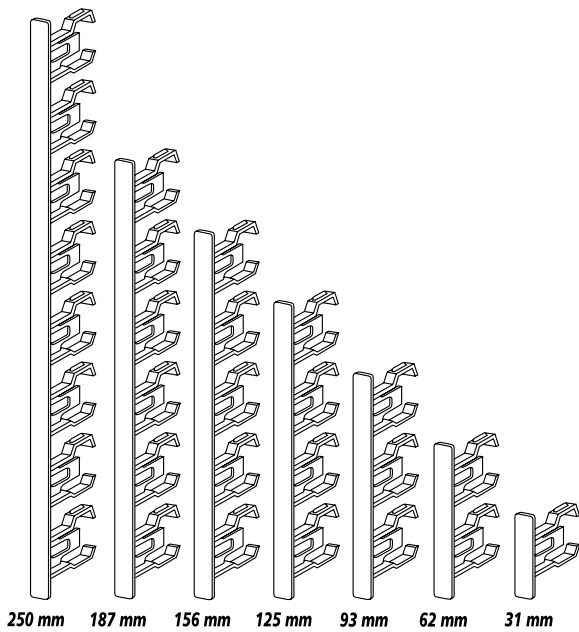

Referencia	Lama	Color	€/unidad
TP1C31GR / TP1C31NE	31 mm.	GRIS / NEGRO	0,43
TP1C62GR / TP1C62NE	62 mm.	GRIS / NEGRO	0,57
TP1C93GR / TP1C93NE	93 mm.	GRIS / NEGRO	0,65
TP1C125GR / TP1C125NE	125 mm.	GRIS / NEGRO	0,72
TP1C156GR / TP1C156NE	156 mm.	GRIS / NEGRO	0,77
TP1C187GR / TP1C187NE	187 mm.	GRIS / NEGRO	0,85
TP1C250GR / TP1C250NE	250 mm.	GRIS / NEGRO	1,37

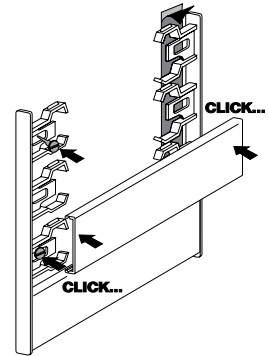

TAPA DE PLÁSTICO DOBLE CARA

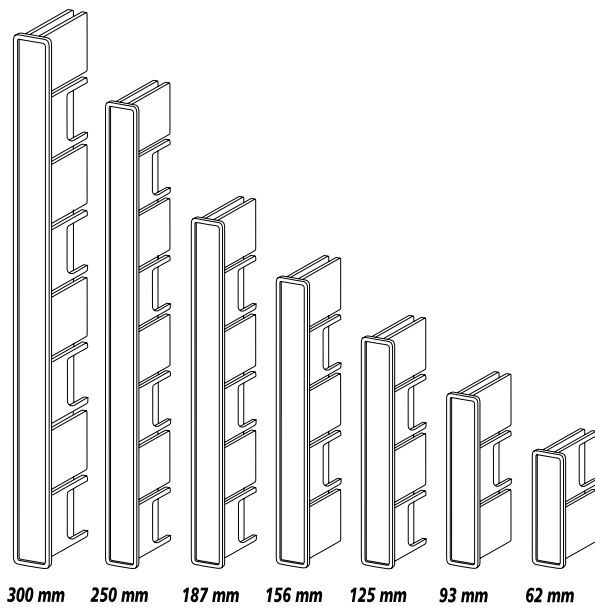

Referencia	Lama	Color	€/unidad
TP2C62GR / TP2C62NE	62 mm.	GRIS / NEGRO	0,87
TP2C93GR / TP2C93NE	93 mm.	GRIS / NEGRO	0,96
TP2C125GR / TP2C125NE	125 mm.	GRIS / NEGRO	1,06
TP2C156GR / TP2C156NE	156 mm.	GRIS / NEGRO	1,15
TP2C187GR / TP2C187NE	187 mm.	GRIS / NEGRO	1,69
TP2C250GR / TP2C250NE	250 mm.	GRIS / NEGRO	1,86
TP2C300NE	300 mm.	NEGRO	2,64

Perfil para rótulo suspendido



Referencia	€/metro
PSRS	14,16

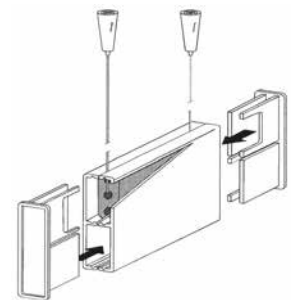

TAPA TRIÁNGULO DE SOBREMESA

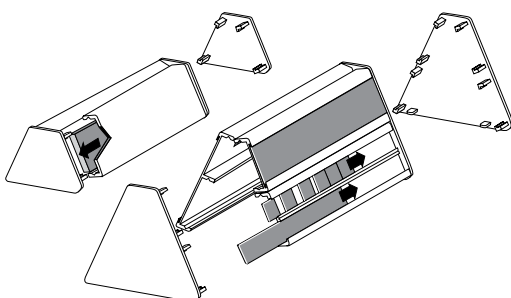

Referencia	Lama	Color	€/unidad
TTS31GR / TTS31NE	31 mm.	GRIS / NEGRO	0,55
TTS62GR / TTS62NE	62 mm.	GRIS / NEGRO	0,98

DIRECTORIOS | ESQUEMA DE MONTAJE

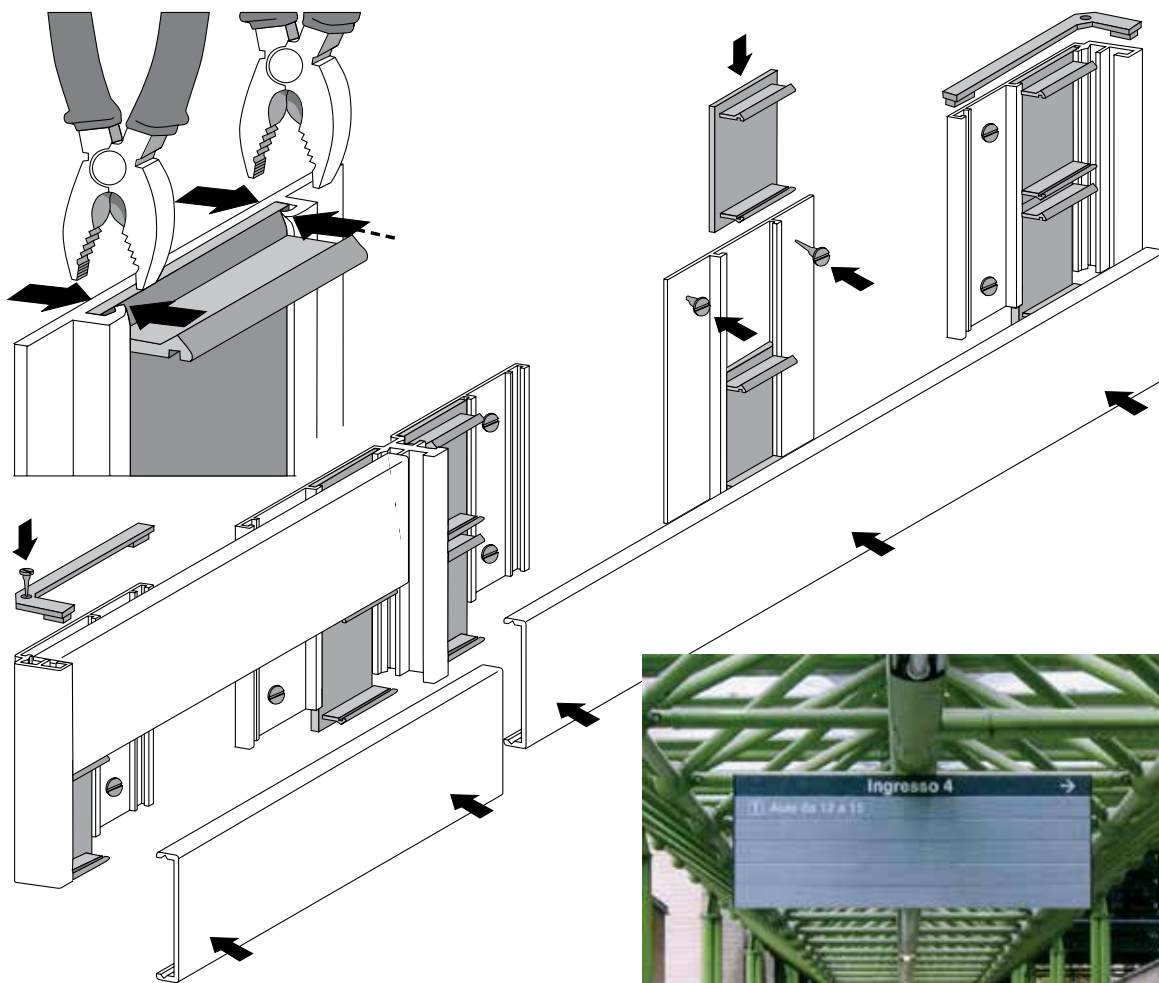

CERCOS

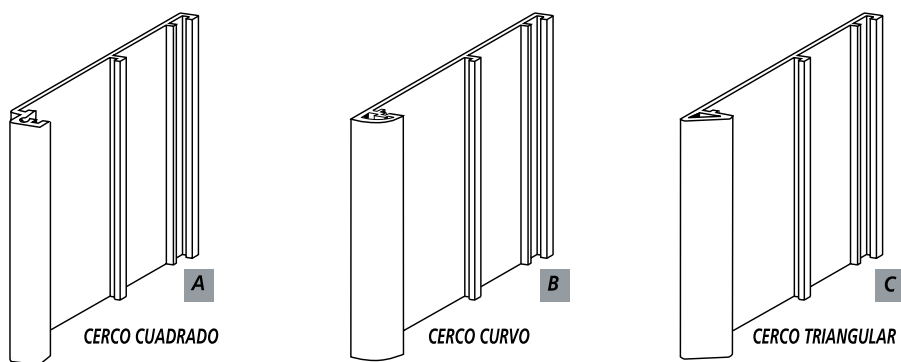

Referencia	Color	€/metro
CECUAG	BRUTO	7,02
CECURAG	BRUTO	8,35
CETRIAG	BRUTO	7,73
CECUAGPL	ANODIZADO	9,57
CECURAGPL	ANODIZADO	12,19
CETRIAGPL	ANODIZADO	11,20

GUÍAS INTERMEDIAS

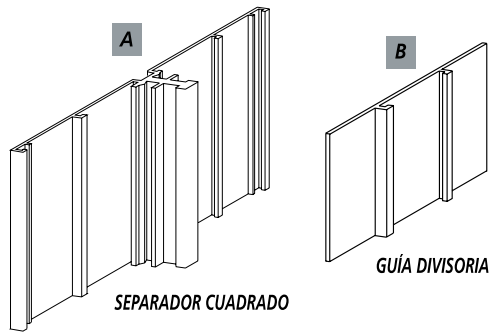

Referencia	Color	€/metro
SECUAG	BRUTO	9,95
GDAG	BRUTO	3,95
SECUAGPL	ANODIZADO	12,59

LAMAS FINALES

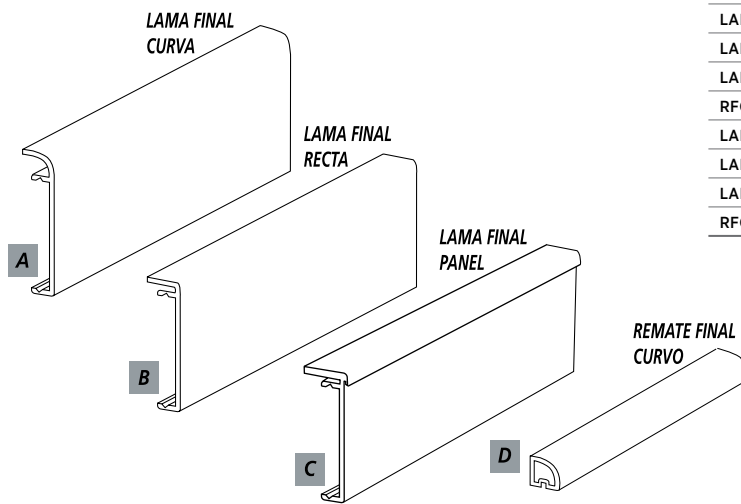

Referencia	Lama	Color	€/metro
LAMAFCAAG	A	BRUTO	5,92
LAMAFRAG	B	BRUTO	5,68
LAMAFPAG	C	BRUTO	5,68
RFCAG	D	BRUTO	4,11
LAMAFCAAGPL	A	ANODIZADO	8,69
LAMAFRAGPL	B	ANODIZADO	8,05
LAMAFPAGPL	C	ANODIZADO	8,05
RFCAGPL	D	ANODIZADO	6,16



TAPAS

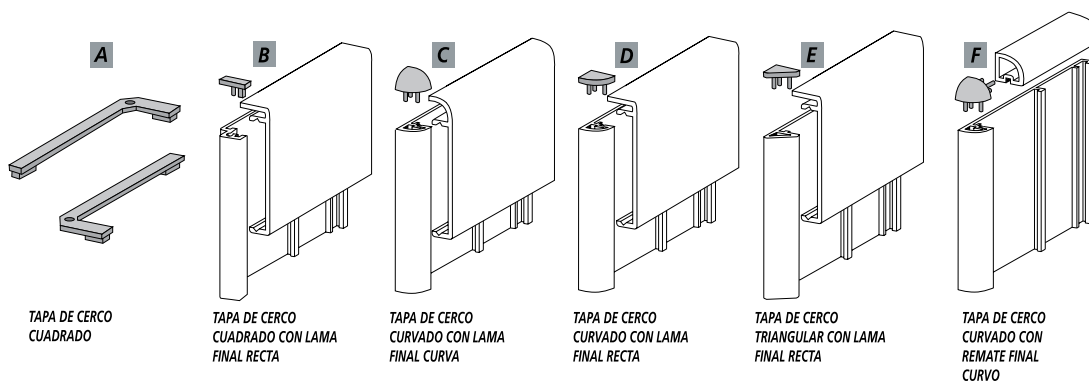

Referencia	Color	€/unidad
TCEUGR / TCEUNE	GRIS / NEGRO	0,50
TCEULFRGR / TCEULFRNE	GRIS / NEGRO	0,50
TCEURFCGR / TCEURFCNE	GRIS / NEGRO	0,69
TCEURLRGR / TCEURLRNE	GRIS / NEGRO	0,63
TCETRILFRGR / TCETRILFRNE	GRIS / NEGRO	0,63
TCEURRFCGR / TCEURRFCNE	GRIS / NEGRO	0,79

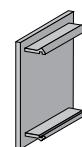

MULTIPINZA

Referencia	€/unidad
MULTIAG	0,21

DIRECTORIOS | ESQUEMA DE MONTAJE

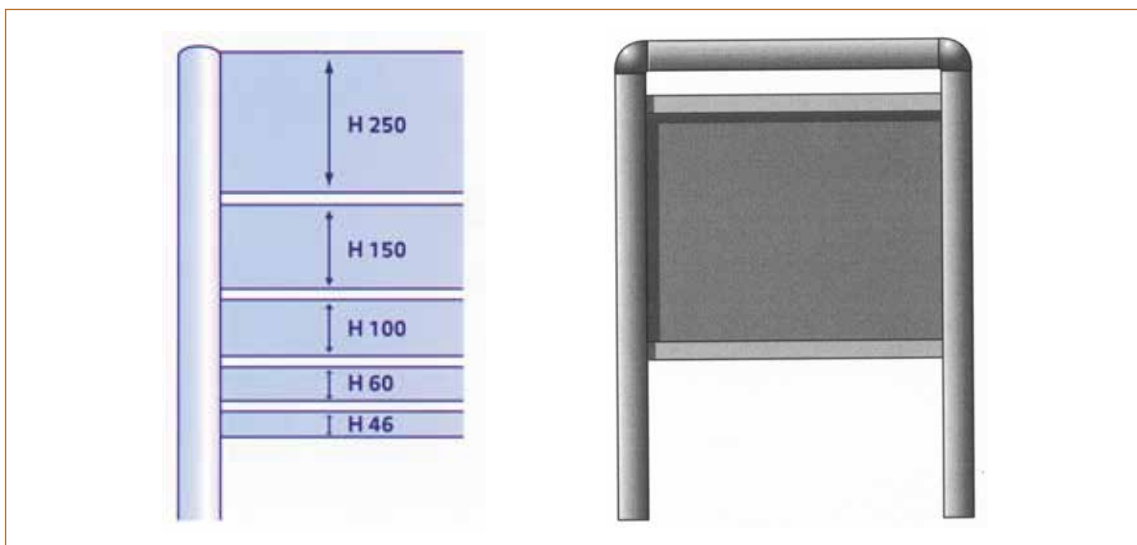
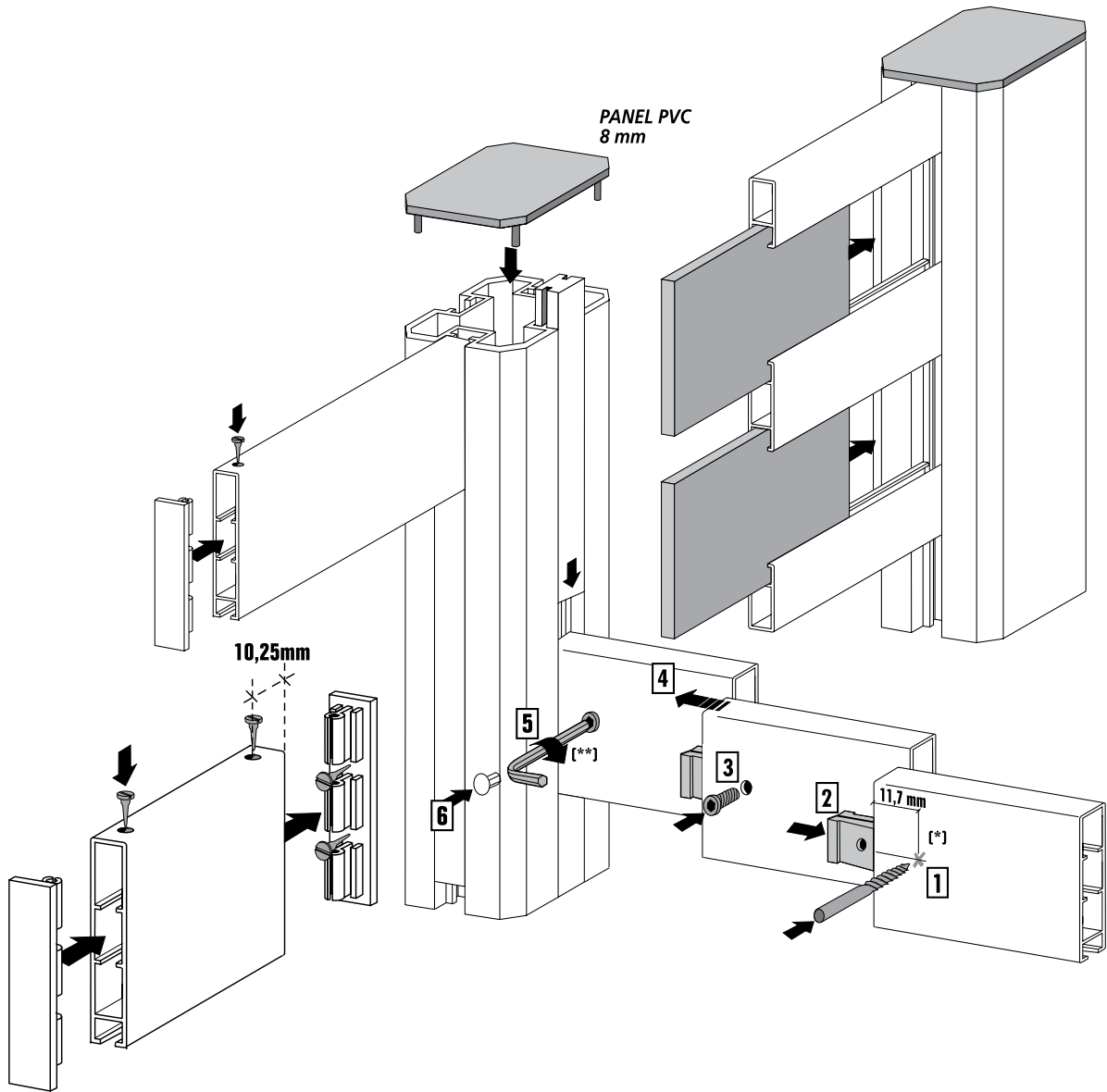

## LAMAS

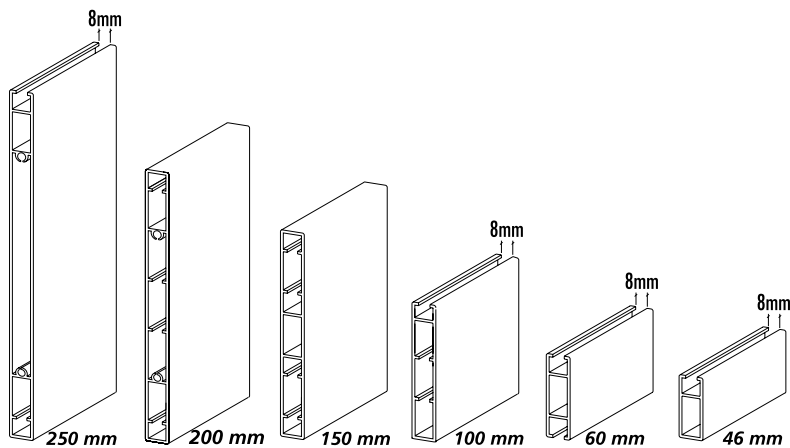

Referencia	Lama	Color	€/metro
LSME46	46 mm.	BRUTO	11,60
LSME60	60 mm.	BRUTO	15,07
LSME100	100 mm.	BRUTO	24,13
LSME150	150 mm.	BRUTO	36,70
LSME200	200 mm.	BRUTO	44,64
LSME250	250 mm.	BRUTO	75,75
LSME46PL	46 mm.	ANODIZADO	14,53
LSME60PL	60 mm.	ANODIZADO	18,83
LSME100PL	100 mm.	ANODIZADO	29,23
LSME150PL	150 mm.	ANODIZADO	38,99
LSME200PL	200 mm.	ANODIZADO	53,19
LSME250PL	250 mm.	ANODIZADO	67,92

## PRISIONERO DE PANEL

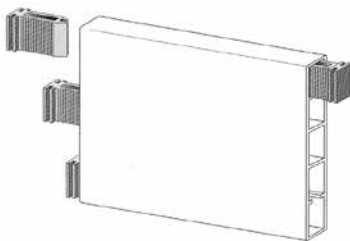

Referencia	€/unidad
PRP	2,96

## TAPAS DE ALUMINIO

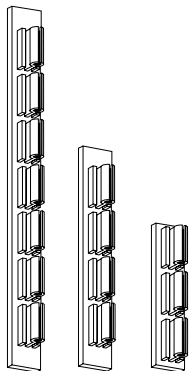

Referencia	Lama	€/unidad
TSME100	100 mm.	6,21
TSME150	150 mm.	6,54
TSME250	250 mm.	8,81
TSME100PL	100 mm.	6,59
TSME150PL	150 mm.	7,01
TSME250PL	250 mm.	9,69

## JUNQUILLOS PARA POSTES

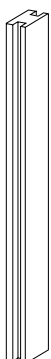

### JUNQUILLO CUBRE-GUÍAS

Referencia	Color	€/metro
JCG	BRUTO	7,33
JCGPL	ANODIZADO	8,43

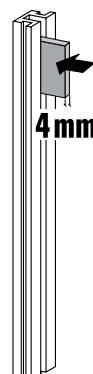

### JUNQUILLO REDUCTOR

Referencia	Color	€/metro
JRE	BRUTO	7,20
JREPL	ANODIZADO	9,04

## POSTES CIRCULARES

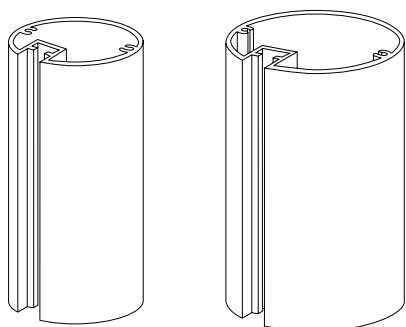

**POSTE CIRCULAR Ø 60 MM/ Ø 90 MM**

Referencia	Ø mm.	Color	€/metro
PC60	60	BRUTO	31,39
PC60PL	60	ANODIZADO	37,70
PC80	90	BRUTO	52,12
PC80PL	90	ANODIZADO	54,60

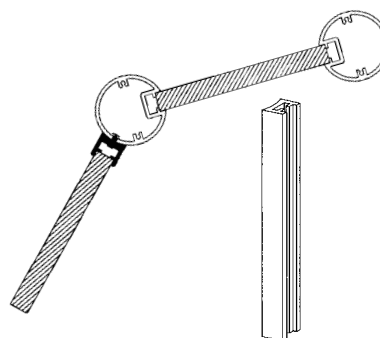

**ADAPTADOR PARA POSTE CIRCULAR Ø 60 MM**

Referencia	Ø mm./poste	Color	€/metro
ADPC60	60	BRUTO	10,19
ADPC60PL	60	ANODIZADO	14,64

## TAPAS PARA POSTE CIRCULAR

**TAPA CIRCULAR DE PLÁSTICO Ø 60 MM**



**TAPA CIRCULAR DE ALUMINIO Ø 60 MM**

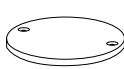

**TAPA CIRCULAR DE ALUMINIO Ø 90 MM**



Referencia	Ø mm./poste	Material	Terminación	€/unidad
TCP60B	60	PLÁSTICO	BLANCO	1,16
TCP60G	60	PLÁSTICO	GRIS	1,16
TCP60N	60	PLÁSTICO	NEGRO	1,16
TCA60	60	ALUMINIO	BRUTO	4,90
TCA60PL	60	ALUMINIO	ANODIZADO	5,60
TCA	90	ALUMINIO	BRUTO	6,49
TCAPL	90	ALUMINIO	ANODIZADO	7,46

## CANTONERA Y TORNILLO POSTE CIRCULAR



**CANTONERA POSTE CIRCULAR Ø 90 MM**

Referencia	Ø mm./poste	Color	€/unidad
CPC	90	BRUTO	34,67



**TORNILLO TAPA POSTE CIRCULAR**

Referencia	€/unidad
TTPC	0,20

## ANCLAJES PARA POSTES CIRCULARES

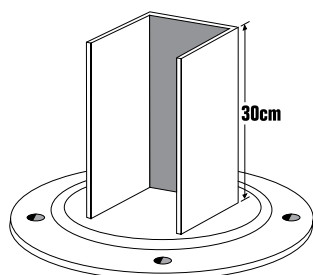

Referencia	Ø mm./poste	€/unidad
APC60	60	64,43
APC	90	64,43

## POSTES OCTOGONALES

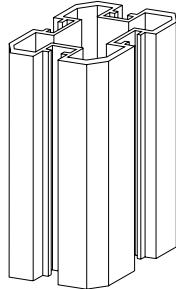
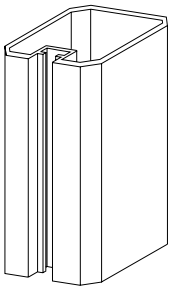

Referencia	Ø mm.	Nº de guías	Color	€/metro
PO801	80	1	BRUTO	45,73
PO801PL	80	1	ANODIZADO	47,60
PO804	80	4	BRUTO	52,05
PO804PL	80	4	ANODIZADO	60,69

**POSTE OCTOGONAL  
80 MM 1 GUÍA**

**POSTE OCTOGONAL  
80 MM 4 GUÍAS**

## TAPAS PARA POSTE OCTOGONAL

**TAPA OCTOGONAL  
DE PLÁSTICO Ø 80 MM  
1 GUÍA**

**TAPA OCTOGONAL DE  
ALUMINIO Ø 80 MM  
1/4 GUÍAS**

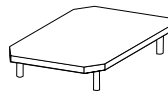
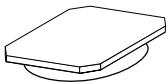

Referencia	Ø mm./poste	Material	Terminación	€/unidad
TOCPB	80	PLÁSTICO	BLANCA	1,57
TOCPG	80	PLÁSTICO	GRIS	1,57
TOCPN	80	PLÁSTICO	NEGRA	1,57
TOCA	80	ALUMINIO	BRUTO	8,49

## ANCLAJES PARA POSTES OCTOGONALES

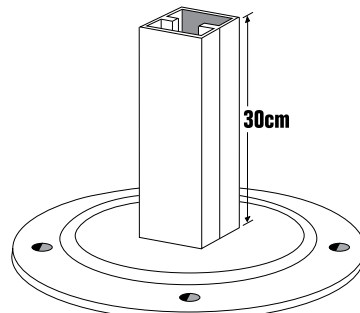
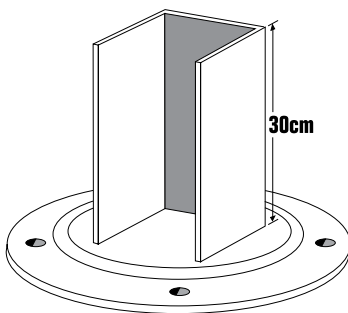

**ANCLAJE POSTE  
OCTOGONAL 1 GUÍA**

**ANCLAJE POSTE  
OCTOGONAL 4 GUÍAS**

Referencia	Nº de guías del poste	€/unidad
APO1	1	64,43
APO4	4	64,43

# APILGRAF LIGHT

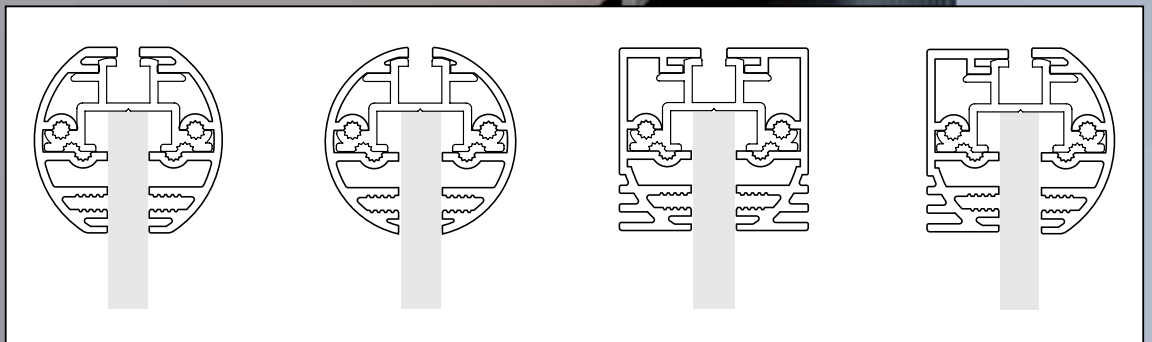

## COMBINACIONES

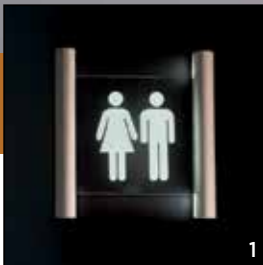

1



2



3

APIL continúa ampliando la gama de aplicaciones de los LED con el diseño de este nuevo producto incluido en la familia de señalización.

Los LED proporcionan numerosas opciones creativas debido a la diversidad de colores, dimensiones compactas y módulos flexibles.

ApilGraf Light consiste en un conjunto de perfiles de aluminio redondeados, curvados y cuadrados, fáciles de combinar para crear diferentes diseños, que se pueden suspender al techo y anclar a la pared en banderola o formando directorios.

## PERFILES

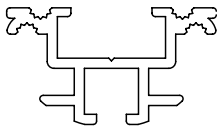

**BÁSICO**

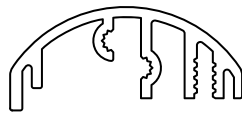

**CURVADO**

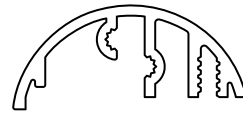

**REDONDO**

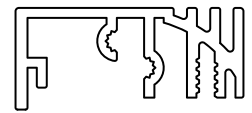

**CUADRADO**

Referencia	Descripción	Terminación	€/metro
AGLB	BÁSICO	BRUTO	6,47
AGLC	CURVADO	BRUTO	6,85
AGLR	REDONDO	BRUTO	6,37
AGLCU	CUADRADO	BRUTO	8,72
AGLCPL	CURVADO	ANODIZADO PLATA	9,74
AGLRPL	REDONDO	ANODIZADO PLATA	9,09
AGLCUPL	CUADRADO	ANODIZADO PLATA	12,36

## ACCESORIOS



**TAPA PARA PERFILES REDONDOS Ø 8 MM**



**TAPA PARA PERFILES CURVADOS Ø 8 MM**



**TAPA PARA PERFILES CUADRADOS Ø 8 MM**



**TAPA PARA COMBINACIÓN DE PERFILES CUADRADO + CURVADO Ø 8 MM**



**ANCLAJE PARA SUJETAR A PARED TODOS LOS PERFILES**

Referencia	Utilización	€/unidad
APAGL	PARA TODOS LOS PERFILES	9,01

Referencia	Tapa para perfil:	€/unidad
TAGLR	REDONDO	7,57
TAGLC	CURVADO	7,57
TAGLCU	CUADRADO	7,57
TAGLCC	CUADRADO+CURVADO	7,57

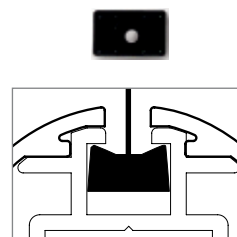

**CLIP DE SUSPENSIÓN**

Referencia	€/unidad
CSAGL	0,35



**CÓNICO  
2 SOPORTES TECHO/CABLES**



**INOXIDABLE  
2 SOPORTES TECHO/CABLES**

**KIT DE SUSPENSIÓN**

Referencia	Descripción	Composición kit	€/unidad
SCAGL	KIT DE SUSPENSIÓN CÓNICO	2 soportes techo+2 cables	31,80
SIAGL	KIT DE SUSPENSIÓN INOXIDABLE	2 soportes techo+2 cables	31,80

# I-SIGN FLEX

El **I-Sign FLEX** es un sistema de señalización flexible, que puede ser instalado y actualizado en poco tiempo, haciéndolo perfecto para ambientes que requieren ser actualizados con regularidad (por ejemplo; hospitales, colegios, oficinas,...)

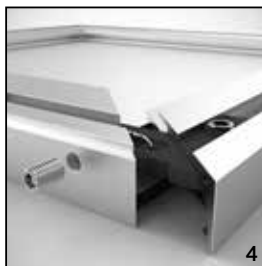
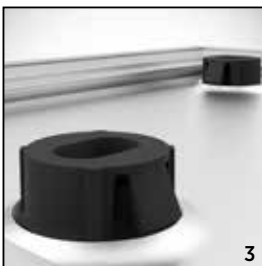
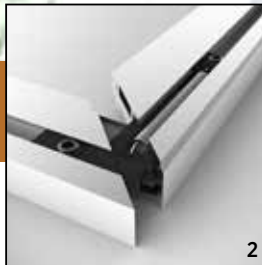

La cubierta acrílica antirreflejos está a nivel con la parte superior del marco de aluminio, dándole un aspecto elegante.

La impresión se puede cambiar fácilmente moviendo la cubierta acrílica con una ventosa y con ayuda de un ingenioso mecanismo de escuadras con muelle patentado.

Para colgar o ajustar en la pared una señal de doble cara se pueden utilizar los I-Button.

Para prevenir actuaciones bandálicas el marco va equipado con una función de bloqueo.

## PERFILES

### I-FLEX 1

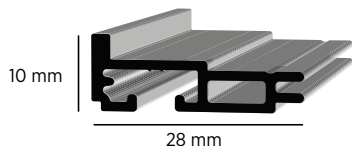

Referencia	Terminación	Medidas	€/metro
IFL1PL	Anodizado plata	Barras de 2,5mts.	<b>6,35</b>

### I-FLEX 2

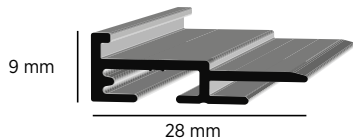

Referencia	Terminación	Medidas	€/metro
IFL2PL	Anodizado plata	Barras de 2,5mts.	<b>5,13</b>

### I-FLEX 3

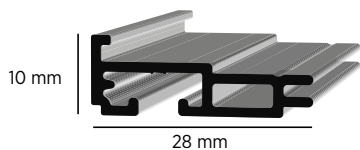

Referencia	Terminación	Medidas	€/metro
IFL3PL	Anodizado plata	Barras de 2,5mts.	<b>6,28</b>

### I-FLEX 4

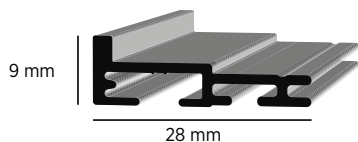

Referencia	Terminación	Medidas	€/metro
IFL4PL	Anodizado plata	Barras de 2,5mts.	<b>5,83</b>

### I-FLAG

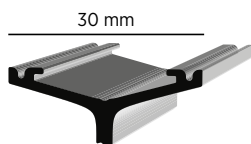

Referencia	Terminación	Medidas	€/metro
IFF	Anodizado plata	Barras de 2,5mts.	<b>29,28</b>

## ACCESORIOS

### Set escuadras I-FLEX



Set de 4 escuadras. 2 Fijas y 2 con muelle

Referencia	€/set
EIFL	<b>4,20</b>

### I-BUTTON



Referencia	€/unidad
BUFL	<b>0,70</b>

### I-BRACKET



Referencia	€/unidad
BRFF	<b>3,03</b>

# I-SIGN FLEX

El **I-Sign FLEX** es un sistema de señalización flexible, que puede ser instalado y actualizado en poco tiempo, haciéndolo perfecto para ambientes que requieren ser actualizados con regularidad (por ejemplo; hospitales, colegios, oficinas,...)



## MARCOS TERMINADOS

Referencia	Descripción	Medidas internas mm.	Medidas externas mm.	DIN	Stock	€/unidad
P52148	Pared	52 x 148,5	57,5 x 152		En stock	<b>17,14</b>
P105107	Pared	105 x 107	110,5 x 110,5		Bajo pedido	<b>17,74</b>
P105148	Pared *	105 x 148,5	110,5 x 152	DIN A6	En stock	<b>18,29</b>
PD105148	Pared con deslizante *	105 x 148,5	110,5 x 152	DIN A6	Bajo pedido	<b>36,29</b>
P148150	Pared *	148,5 x 150,5	154 x 154		En stock	<b>21,34</b>
P210148	Pared *	210 x 148,5	215,5 x 152	DIN A5	En stock	<b>25,06</b>
P210212	Pared *	210 x 212	215,5 x 215,5		Bajo pedido	<b>29,09</b>
P210297	Pared *	210 x 297	215,5 x 300,5	DIN A4 L	En stock	<b>33,60</b>
P297210	Pared *	297 x 210	302,5 x 213,5	DIN A4 P	En stock	<b>33,46</b>
P297299	Pared *	297 x 299	302,5 x 302,5		Bajo pedido	<b>39,69</b>
P420297	Pared *	420 x 297	425,5 x 300,5	DIN A3 P	En stock	<b>48,06</b>
P594420	Pared	594 x 420	597,5 x 423,5	DIN A2	Bajo pedido	<b>95,54</b>
P841594	Pared	841 x 594	844,5 x 597,5	DIN A1	Bajo pedido	<b>144,51</b>

S148297	Suspendido	148,5 x 297	152 x 302,5		En stock	<b>90,74</b>
S148420	Suspendido	148,5 x 420	152 x 425,5		Bajo pedido	<b>100,03</b>
S148600	Suspendido	148,5 x 600	152 x 605,5		En stock	<b>112,46</b>
S148840	Suspendido	148,5 x 840	152 x 845,5		Bajo pedido	<b>129,09</b>
S210297	Suspendido	210 x 297	213,5 x 302,5	DIN A4 L	Bajo pedido	<b>98,49</b>
S210420	Suspendido	210 x 420	213,5 x 425,5		Bajo pedido	<b>110,03</b>
S210600	Suspendido	210 x 600	213,5 x 605,5		Bajo pedido	<b>126,26</b>
S210840	Suspendido	210 x 840	213,5 x 845,5		Bajo pedido	<b>147,49</b>

Se entrega con el sistema de suspensión cónica - cable de 1,5 m .

B150148	Banderola	150,5 x 148,5	154 x 154		En stock	<b>56,57</b>
B212210	Banderola	212 x 210	215,5 x 215,5		Bajo pedido	<b>66,51</b>
B210297	Banderola	210 x 297	213,5 x 302,5	DIN A4 L	Bajo pedido	<b>74,46</b>
B297210	Banderola	297 x 210	300,5 x 215,5	DIN A4 P	Bajo pedido	<b>74,46</b>

S052148	Sobremesa	52 x 148,5	57,5 x 152		Bajo pedido	<b>28,00</b>
---------	-----------	------------	------------	--	-------------	--------------

PBPL	Perfil Bandera anodizado plata			2,5 m.		<b>28,74 €/m</b>
SMPB	Soporte de montaje de la bandera (color gris plata)			10 pcs.		<b>2,97 €/unidad</b>
B+S	Banderola con soporte incluido			150 x 161 mm.		<b>10,37 €/unidad</b>

VE	Ventosa			1 pcs.		<b>1,25 €/unidad</b>
----	---------	--	--	--------	--	----------------------

\* Se sirven con soportes para su montaje en pared.

Embalado individualmente en cajas de cartón.

Plástico frontal anti-reflex y sistema de bloqueo.

Otras medidas del I -Sign Flex disponibles bajo pedido.

El **I-Sign FIX** ofrece la solución perfecta para señales que no requieren ser actualizadas periódicamente (Planes de evacuación, señales de seguridad y otros pictogramas).

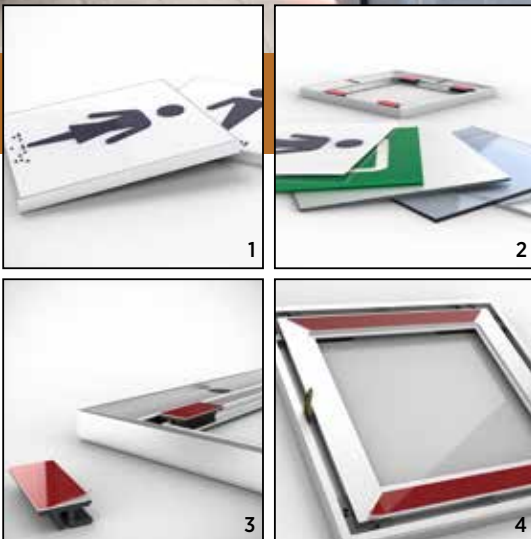

Marco elegante sin fijaciones visibles.

Pueden ser utilizados paneles de diferentes materiales con un grosor de 2-3 mm: hojas de grabado, paneles de braille o letras táctiles, paneles de aluminio, cristal, acrílico, madera, metal...

Para colgar paneles dentro del marco, se utiliza un innovador clip con adhesivo de doble cara. La posición del clip puede alterarse permitiendo la inserción de paneles de 2-3 mm y asegurando que estos estén a nivel con la parte superior del marco de aluminio.

Para colgar el perfil FIX se puede utilizar adhesivo de doble cara o tornillos.

## PERFILES

### I-FIX 1

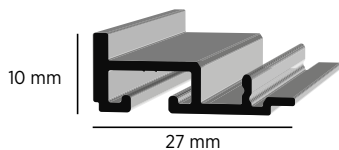

Referencia	Terminación	Medidas	€/metro
IF1PL	Anodizado plata	Barras de 2,5mts.	4,70

### I-FIX 2

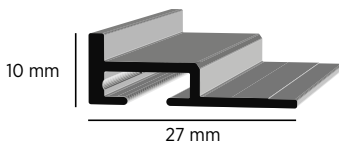

Referencia	Terminación	Medidas	€/metro
IF2PL	Anodizado plata	Barras de 2,5mts.	5,78

### I-FLAG

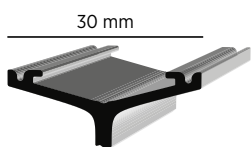

Referencia	Terminación	Medidas	€/metro
IFF	Anodizado plata	Barras de 2,5mts.	29,28

## ACCESORIOS

### IF-CORNER



Referencia	€/unidad
EIF	0,58

### I-CLIP



Referencia	€/unidad
CLF	0,80

### I-CONNECTOR



Referencia	€/unidad
COF	0,58

### I-BRACKET



Referencia	€/unidad
BRFF	3,03

### Clip de suspensión

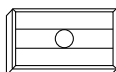

Referencia	€/unidad
CSAGL	0,35

### COLGADOR TORNILLO CROMO



Referencia	€/caja (2 unid.)
SOTCOCR	13,48

### CABLE



Rollo de 25 mts.	
Referencia	€/rollo
CAC	35,00

# I-SIGN DISPLAY

**I-Sign DISPLAY** es la solución perfecta para marcos o paneles de gran formato, impresiones digitales, arte (museos, galerías, etc) y para aplicaciones de decoración interior.

La versión a doble cara se puede utilizar para crear cajas de luz, apropiadas para aeropuertos, centros comerciales, etc.



Marco elegante, pero robusto, de gran tamaño sin fijaciones visibles.

Fácil de colgar, con esquinas especiales. Los paneles se instalan utilizando adhesivo de doble cara o velcro magnético.

Utilizando la nueva generación de LED se pueden crear cajas de luz estrechas, proporcionando soluciones fáciles y económicas.

Apropiado para crear Totems para interiores con y sin luz.

## PERFILES

### I-DISPLAY 1

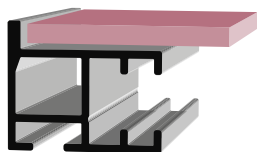

Referencia	Terminación	Medidas	€/metro
ID1PL	Anodizado plata	Barras de 2,5mts.	12,10

### I-DISPLAY 2

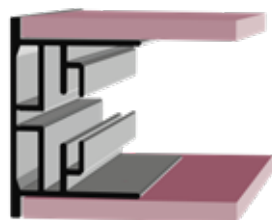

Referencia	Terminación	Medidas	€/metro
ID2PL	Anodizado plata	Barras de 2,5mts.	21,60

## ACCESORIOS

### Set escuadras i-display 1 cara

Referencia	€/set
EID1	14,38

### Set escuadras i-display 2 caras

Referencia	€/set
EID2	30,63

# apil

C / Einstein, 11  
Pol. Ind. Sur M-50  
28914 Leganés (Madrid)

---

Tel.: 916 418 990  
Fax: 916 435 388

---

www.apil.es  
apil@apil.es