

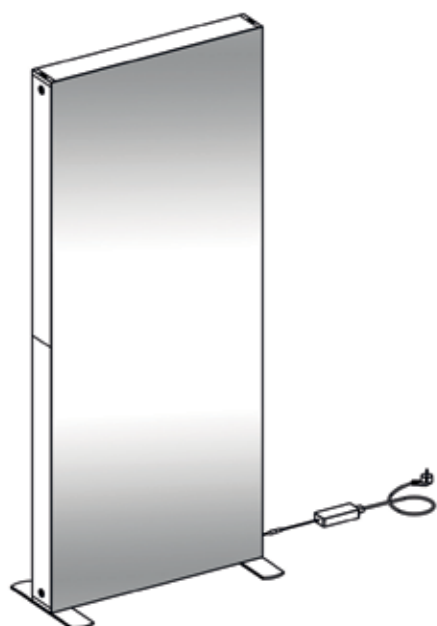

AV  
P

# KIT TEXTIL MÓVIL

## KIT TEXTIL CAJA DE LUZ MÓVIL



Maleta (1150 x 380 x 160 mm)



| Referencia | Medidas mm        | Tiras de LED | Convertidores | Voltage entrada  | Voltage salida | Color | Wattios (W) | Lúmenes x Wattios | Total Lúmenes | Certificados | Nº maletas | €/unidad |
|------------|-------------------|--------------|---------------|------------------|----------------|-------|-------------|-------------------|---------------|--------------|------------|----------|
| KTP100200  | 1000 x 2000 X 120 | 2            | 1             | 100-240v-50/60Hz | DC 24 V        | 6800K | 90          | 130               | 11700         | CE/UL        | 1          | 445,00   |

## KIT TEXTIL MOSTRADOR MÓVIL



Maleta (1120 x 330 x 330 mm)

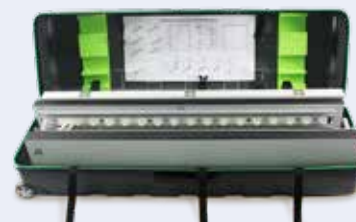

| Referencia | Medidas mm        | Voltage de entrada | Voltage de salida | Peso kit kg | €/unidad |
|------------|-------------------|--------------------|-------------------|-------------|----------|
| KTM        | 1030 x 1053 x 380 | 220-240 V AC       | DC 24 V           | 28,7        | 932,05   |

# KIT TEXTIL MÓVIL

## KIT TEXTIL CAJA DE LUZ MÓVIL CON BATERÍA



| Referencia | Medidas caja de luz mm | Medidas caja de luz + batería mm | Voltaje de entrada         | Peso kit kg | Nº de maletas | €/kit   |
|------------|------------------------|----------------------------------|----------------------------|-------------|---------------|---------|
| KCL+B      | 1000 x 2000 x 100      | 1000 x 2045 x 280                | 2202-240 V AC<br>6 24 V DC | 15 + 16     | 2             | 1637,00 |

## BATERÍA PARA CAJA DE LUZ



Maleta (970 x 320 x 90 mm)



| Referencia | Medidas mm     | Voltaje de entrada | Voltaje de salida | Peso kit kg | Tiempo de uso | Tiempo de recarga | €/unidad |
|------------|----------------|--------------------|-------------------|-------------|---------------|-------------------|----------|
| BAT        | 870 x 280 x 45 | 2202-240 V AC      | DC 24 V           | 16          | Máximo 10 h.  | 8 h.              | 1351,50  |

## MARCO CON LUZ (LED)

### MARCO 20 MM.

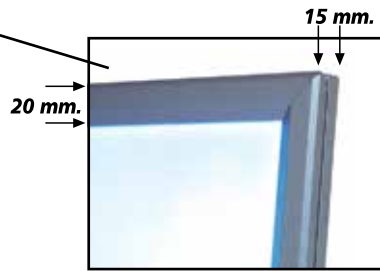
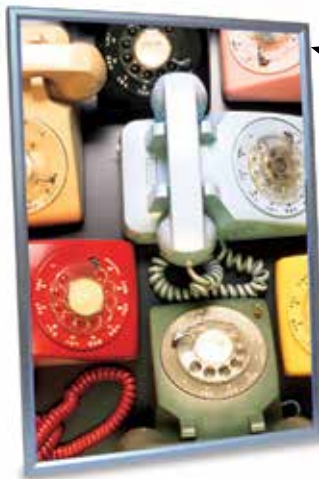

- 1 CARA
- **ESPELOR 15 mm.**
- **PLÁSTICO PROTECTOR**

| Referencia | Formato Imagen | Tamaño Ventana mm. | Medidas (x/y) exteriores mm. | Peso kg. | Medidas embalaje mm. | €/unidad      |
|------------|----------------|--------------------|------------------------------|----------|----------------------|---------------|
| RILL1557   | 510 x 710      | 500 x 700          | 540 x 740                    | 0,30     | 540 x 15 x 740       | <b>180,79</b> |

## MARCO CON LUZ (TUBOS TS)

### 56 MM. ESQUINA INGLETE

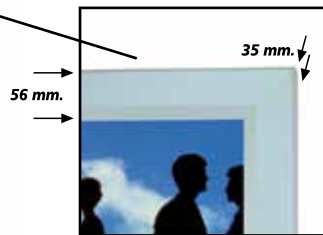

- 1 CARA
- **ESPELOR 35 mm.**
- **PLÁSTICO PROTECTOR**

| Referencia | Formato Imagen | Tamaño Ventana mm. | Medidas (x/y) exteriores mm. | Peso kg. | Medidas embalaje mm. | €/unidad      |
|------------|----------------|--------------------|------------------------------|----------|----------------------|---------------|
| RIT53557   | 540 x 72       | 510 x 695          | 620 x 805                    | 0,30     | 620 x 35 x 805       | <b>206,04</b> |
| RIT535710  | 740 x 1025     | 710 x 995          | 820 x 1105                   | 0,55     | 820 x 35 x 1105      | <b>301,00</b> |

### 52 MM. ESQUINA INGLETE

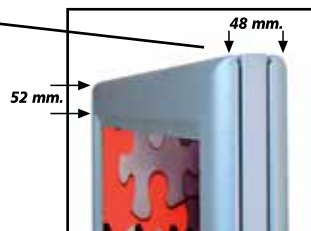

- 2 CARAS
- **ESPELOR 48 mm.**
- **PLÁSTICO PROTECTOR**

| Referencia | Formato Imagen | Tamaño Ventana mm. | Medidas (x/y) exteriores mm. | Peso kg. | Medidas embalaje mm. | €/unidad      |
|------------|----------------|--------------------|------------------------------|----------|----------------------|---------------|
| R2T54857   | 510 x 710      | 500 x 700          | 540 x 740                    | 0,30     | 540 x 48 x 740       | <b>311,76</b> |
| R2T548710  | 710 x 1010     | 700 x 1000         | 740 x 1040                   | 0,55     | 740 x 48 x 1040      | <b>496,30</b> |

## CABALLETE

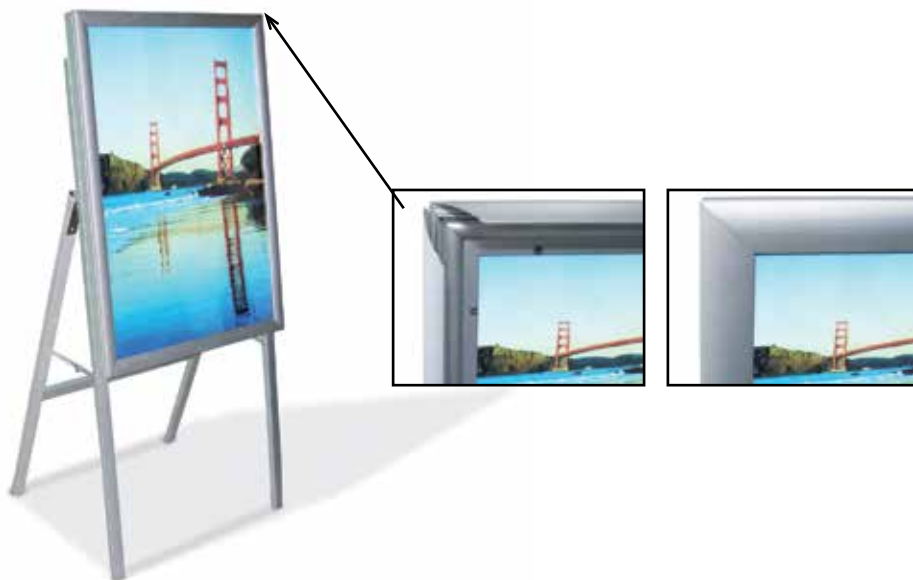

- MARCO 32 mm.
- MARCO ABATIBLE
- ESQUINA INGLETE

| Referencia | Formato Imagen | Tamaño Ventana mm. | Medidas (x/y) exteriores mm. | Iluminación | Medidas embalaje mm. | €/unidad |
|------------|----------------|--------------------|------------------------------|-------------|----------------------|----------|
| KCMAL3257  | 510 x 710      | 500 x 700          | 570 x 770                    | 1 CARA      | 570 x 50 x 770       | 142,45   |

## DE TECHO

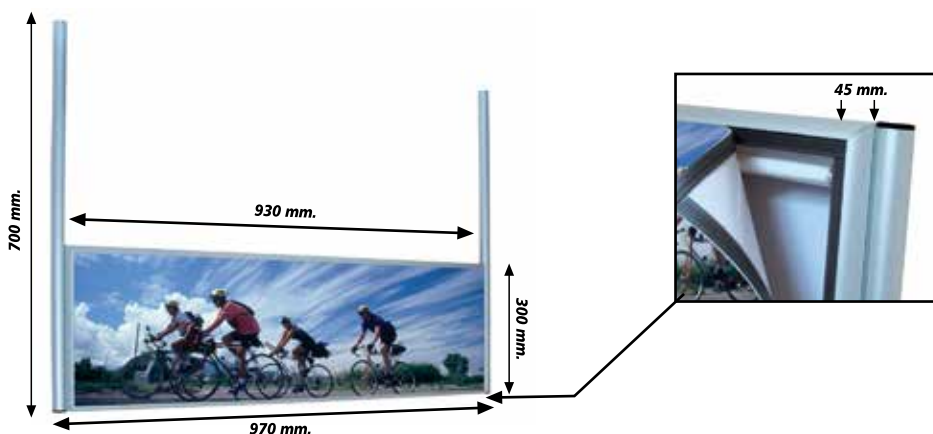

- 2 CARAS
- ESPESOR 45 mm.
- METACRILATO CON BANDA MAGNÉTICA

| Referencia | Formato Imagen | Tamaño Ventana mm. | Medidas (x/y) exteriores mm. | Peso kg. | Medidas embalaje mm. | €/unidad |
|------------|----------------|--------------------|------------------------------|----------|----------------------|----------|
| RTT54539   | 905 x 275      | 905 x 275          | 930 x 300                    | 0,55     | 930 x 45 x 275       | 98,54    |

## SUJETA PLACAS SIMPLE



| Referencia | Color |  | €/caja |
|------------|-------|--|--------|
| CSPSOR     | ORO   | 4  | 15,24  |
| CSPSCR     | CROMO | 4  | 29,19  |
| CSPSPLS    | PLATA | 4  | 31,79  |

## SUJETA PLACAS DOBLE



| Referencia | Color |  | €/caja |
|------------|-------|---|--------|
| CSPDOR     | ORO   | 2   | 10,95  |
| CSPDCR     | CROMO | 2   | 20,77  |
| CSPDPLS    | PLATA | 2   | 21,85  |

## SOPORTE TENSIÓN

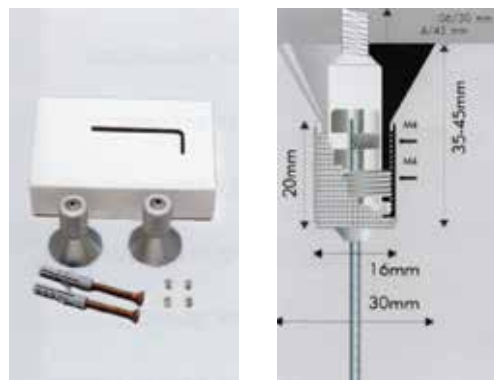

| Referencia | Color |  | €/caja |
|------------|-------|--|--------|
| STOR       | ORO   | 2  | 17,90  |
| STCR       | CROMO | 2  | 35,43  |
| STPLS      | PLATA | 2  | 39,96  |

## SOPORTE TENSIÓN MÓVIL



| Referencia | Color |  | €/caja |
|------------|-------|---|--------|
| STMOR      | ORO   | 2   | 25,33  |
| STMCR      | CROMO | 2   | 50,58  |
| STMPLS     | PLATA | 2   | 60,61  |

## PEQUEÑO



| Referencia | Color |  | €/caja |
|------------|-------|---|--------|
| SOSPOR     | ORO   | 8   | 53,89  |
| SOSPCR     | CROMO | 8   | 38,99  |
| SOSPPLS    | PLATA | 8   | 55,59  |

## MEDIANO



| Referencia | Color |  | €/caja |
|------------|-------|---|--------|
| SOSMOR     | ORO   | 4   | 28,28  |
| SOSMCR     | CROMO | 4   | 21,06  |
| SOSMPLS    | PLATA | 4   | 23,17  |

## GRANDE



| Referencia | Color |  | €/caja |
|------------|-------|---|--------|
| SOSGOR     | ORO   | 4   | 65,94  |
| SOSGCR     | CROMO | 4   | 49,95  |
| SOSGPLS    | PLATA | 4   | 64,97  |

## LATERAL



| Referencia | Color |  | €/caja |
|------------|-------|---|--------|
| SOSLCR     | CROMO | 4   | 56,73  |
| SOSLPLS    | PLATA | 4   | 62,18  |

## ACERO 15

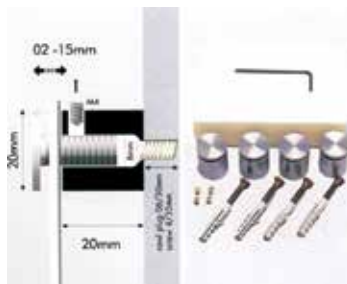

| Referencia | Color |  | €/caja |
|------------|-------|--|--------|
| SSA15      | PLATA | 4  | 25,47  |

## ACERO 20

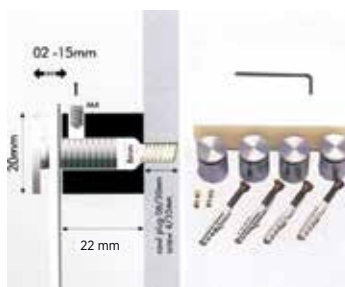

| Referencia | Color |  | €/caja |
|------------|-------|---|--------|
| SSA20      | ACERO | 4   | 33,26  |

## GRUESO VARIABLE



| Referencia | Color |  | €/caja |
|------------|-------|---|--------|
| SSPGOR     | ORO   | 4   | 29,45  |
| SSPGCR     | CROMO | 4   | 63,01  |
| SSPGPLS    | PLATA | 4   | 75,87  |

## PLÁSTICO



| Referencia | Color        |  | €/caja |
|------------|--------------|---|--------|
| SSPT       | TRANSPARENTE | 4   | 11,57  |
| SSPN       | NEGRO        | 4   | 5,91   |
| SSPG       | GRIS         | 4   | 5,91   |
| SSPB       | BLANCO       | 4   | 5,91   |
| SSPC       | CROMO        | 4   | 8,68   |
| SSPP       | PLATA        | 4   | 10,68  |

## SEPARADOR OCULTO

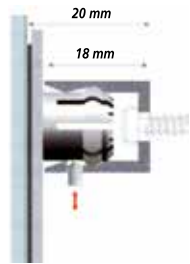
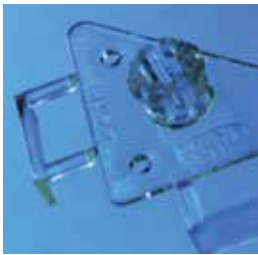

| Referencia |  | €/caja |
|------------|--|--------|
| SSO        | 4  | 15,61  |

## PERFIL CARRIL

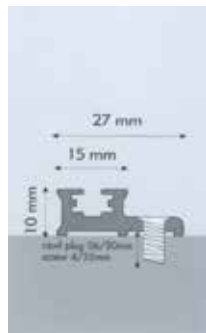

| Referencia | Color    | Metros/barra | €/metro |
|------------|----------|--------------|---------|
| CA         | ALUMINIO | 1,4          | 50,92   |

## BOTÓN DE UNIÓN



| Referencia | Color |  | €/caja |
|------------|-------|--|--------|
| SBUCR      | CROMO | 4  | 24,95  |
| SBUPLS     | PLATA | 4  | 25,06  |

## SOPORTE PRESIÓN

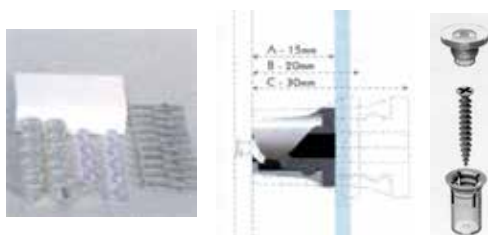

| Referencia | Color  | Medidas        |  | €/caja |
|------------|--------|----------------|---|--------|
| SP15       | BLANCO | 15 mm. Ø15 mm. | 10  | 9,48   |
| SP20       | BLANCO | 20 mm. Ø20 mm. | 10  | 11,28  |
| SP30       | BLANCO | 30 mm. Ø20 mm. | 10  | 11,66  |

PRISIONERO ESFÉRICO



| Referencia | Color |  | €/caja |
|------------|-------|---|--------|
| PECR       | CROMO | 4   | 9,33   |

PRISIONERO CÓNICO



| Referencia | Color |  | €/caja |
|------------|-------|---|--------|
| PCPLS      | PLATA | 4   | 23,67  |

CABLE DE ACERO INOXIDABLE



| Referencia | Metros/rollo | €/rollo |
|------------|--------------|---------|
| CAC        | 25           | 42,67   |

COLGADOR TORNILLO

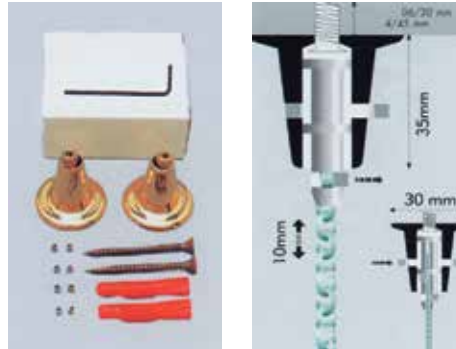

| Referencia | Color |  | €/caja |
|------------|-------|---|--------|
| SOTCOOR    | ORO   | 2   | 8,42   |
| SOTCOCR    | CROMO | 2   | 22,09  |
| SOTCOPLS   | PLATA | 2   | 24,88  |

COLGANTE BOTELLA



| Referencia | Color |  | €/caja |
|------------|-------|---|--------|
| SOTCOR     | ORO   | 2   | 8,69   |
| SOTCCR     | CROMO | 2   | 19,07  |
| SOTCPLS    | PLATA | 2   | 21,91  |

COLGADOR ACERO

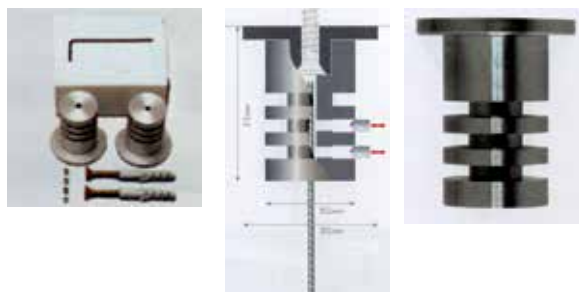
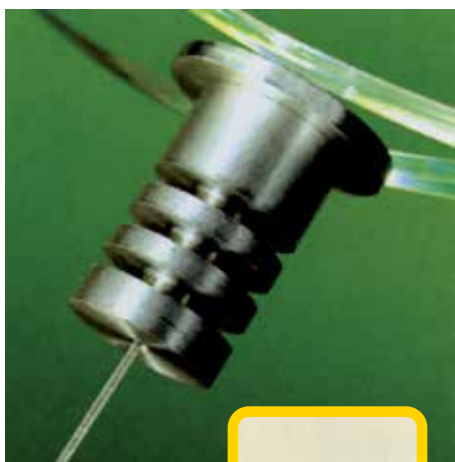

| Referencia | Color |  | €/caja |
|------------|-------|---|--------|
| SCOA       | ACERO | 2   | 54,95  |

COLGANTE ACERO

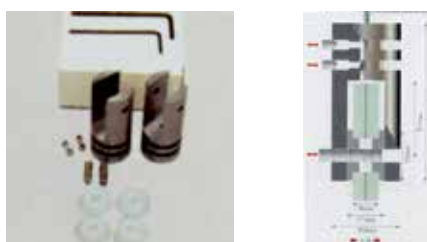
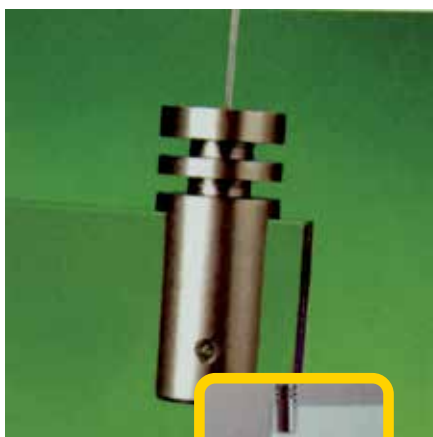

| Referencia | Color |  | €/caja |
|------------|-------|---|--------|
| SCA        | ACERO | 2   | 63,00  |

## COLGADOR AUTOMÁTICO



| Referencia | Color |  | €/caja |
|------------|-------|--|--------|
| SOTACR     | CROMO | 2  | 26,73  |
| SOTAPLS    | PLATA | 2  | 30,90  |

## COLGADOR BOTÓN

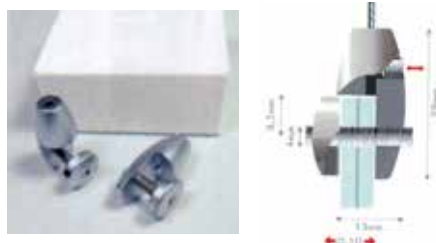

| Referencia | Color |  | €/caja |
|------------|-------|--|--------|
| SCOBPLS    | PLATA | 2  | 15,48  |

## COLGANTE DOBLE BOTÓN

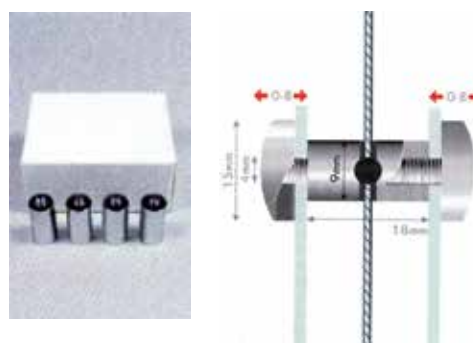

| Referencia | Color |  | €/caja |
|------------|-------|---|--------|
| SCDBPLS    | PLATA | 4   | 9,76   |

## COLGANTE GANCHO

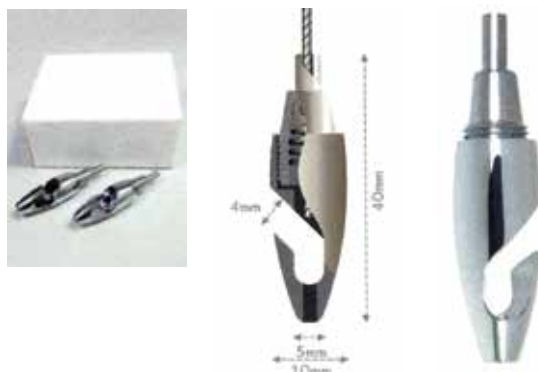

| Referencia | Color |  | €/caja |
|------------|-------|--|--------|
| SCGCR      | CROMO | 2  | 25,34  |

## BANDEROLA BOTELLA

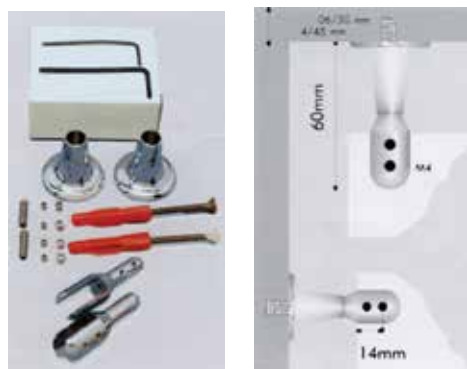

| Referencia | Color |  | €/caja |
|------------|-------|---|--------|
| SOBOR      | ORO   | 2   | 13,38  |
| SOBCR      | CROMO | 2   | 32,21  |
| SOBPLS     | PLATA | 2   | 35,27  |

## BANDEROLA ACERO



| Referencia | Color |  | €/caja |
|------------|-------|---|--------|
| SBA        | ACERO | 2   | 55,08  |

## UNIÓN DOBLE BOTÓN

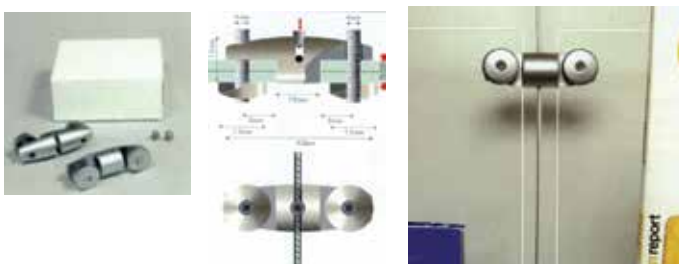
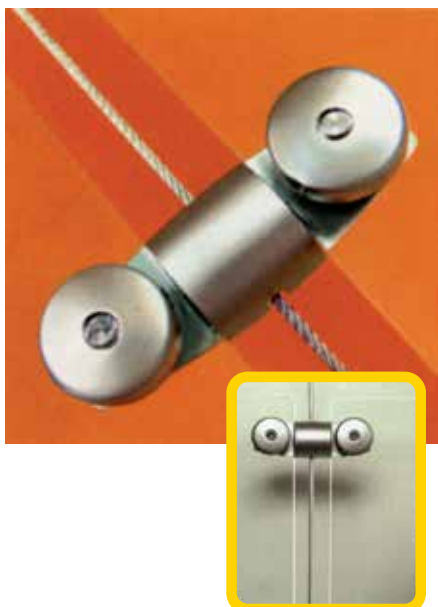

| Referencia | Color |  | €/caja |
|------------|-------|---|--------|
| SDBCR      | CROMO | 2   | 14,92  |
| SDBPLS     | PLATA | 2   | 17,01  |

## UNIÓN DOBLE FLECHA

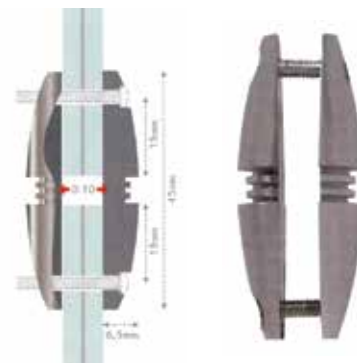

| Referencia | Color |  | €/caja |
|------------|-------|---|--------|
| SDFA       | ACERO | 2   | 29,60  |

## PORTAFOLLETOS



| Referencia | Descripción          | €/unidad |
|------------|----------------------|----------|
| PA5H       | DIN A-5 HORIZONTAL   | 12,75    |
| PA4H       | DIN A-4 HORIZONTAL   | 19,38    |
| PA4V       | DIN A-4 VERTICAL     | 10,43    |
| P2A4V      | 2 x DIN A-4 VERTICAL | 47,51    |
| P3A4V      | 3 x DIN A-4 VERTICAL | 63,76    |
| PA3H       | DIN A-3 HORIZONTAL   | 23,25    |
| PA3V       | DIN A-3 VERTICAL     | 20,97    |

# PORTAFOLLETOS ABATIBLE PLANO

PARA PARED O CRISTAL

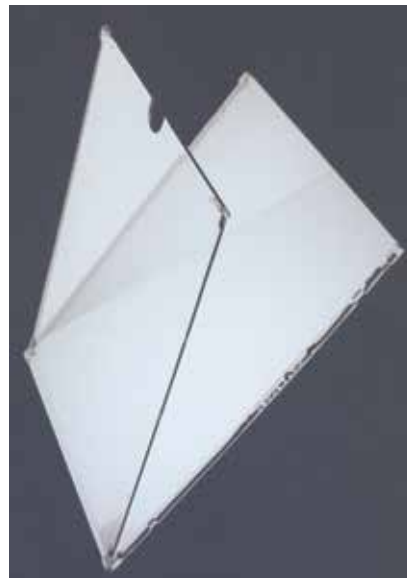

| Referencia | Dimensiones        |  | €/unidad |
|------------|--------------------|---|----------|
| PAA4H      | DIN A-4 HORIZONTAL | 20  | 24,38    |
| PAA4V      | DIN A-4 VERTICAL   | 20  | 24,38    |
| PAA5H      | DIN A-5 HORIZONTAL | 20  | 20,63    |
| PAA5V      | DIN A-5 VERTICAL   | 20  | 20,63    |

# PORTAFOLLETOS ABATIBLE CURVO

## PORTAFOLLETOS

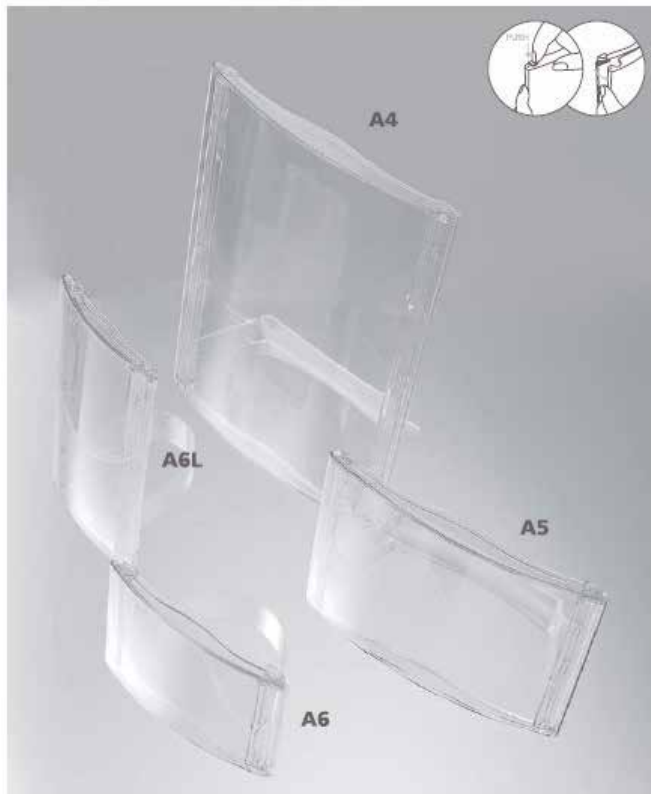

| Referencia | Descripción   | Tamaño        | €/unidad |
|------------|---------------|---------------|----------|
| PAC4       | Portafolletos | A4 (210x297)  | 21,83    |
| PAC5       | Portafolletos | A5 (148x210)  | 19,69    |
| PAC6       | Portafolletos | A6 (105x148)  | 13,80    |
| PAC6L      | Portafolletos | A6L (105x210) | 16,59    |
| SPAC       | Soporte       | -----         | 3,24     |



**PAC 4**



**PAC 5**



**PAC 6**



**PAC 6L**



**SPAC**

- Portafolletos
- Soporte
- Cinta adhesiva doble cara
- Tacos de fijación (2)

- Portafolletos
- Cinta adhesiva doble cara
- Tacos de fijación (2)

- Soporte

# PORTAFOLLETOS ABATIBLE CURVO

## CON ANCLAJE Y SOPORTE DE PIE

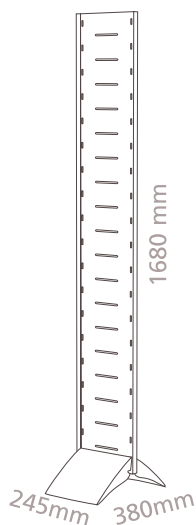

| Referencia | Descripción               | Tamaño           | €/unidad |
|------------|---------------------------|------------------|----------|
| PCDO       | Soporte de pie            | 245x380x1680 mm. | 192,60   |
| CAP4       | Portafolletos con anclaje | A4 (Vertical)    | 28,46    |
| CAP5       | Portafolletos con anclaje | A5 (Horizontal)  | 21,40    |

## KIT DE PARED



### KSP

- Soporte de tensión (2)
- Tacos de fijación (2)
- Cable de acero
- Barra de suspensión



### PP4V

- Portafolletos A4 vertical



### KFP

- Soporte de tensión (4)
- Tacos de fijación (4)
- Cable de acero



### PP5H

- Portafolletos A5 horizontal



### SOFP

- Soporte de unión cable/portafolletos (4)

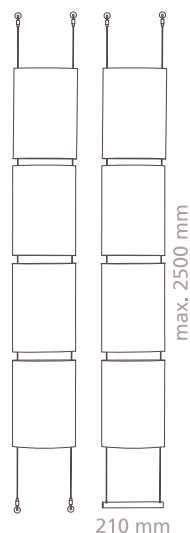

| Referencia | Descripción                  | Tamaño          | €/unidad |
|------------|------------------------------|-----------------|----------|
| KSP        | Kit suspensión               | -----           | 57,78    |
| KFP        | Kit fijación                 | -----           | 66,20    |
| SOFP       | Caja soporte fijación (4 u.) | -----           | 21,68    |
| PP4V       | Portafolletos                | A4 (Vertical)   | 19,58    |
| PP5H       | Portafolletos                | A5 (Horizontal) | 15,84    |

# PANEL EMERGENTE



## MAGNÉTICO CURVO A

| Referencia | Medidas       | €/unidad |
|------------|---------------|----------|
| MGA33      | 300 x 300 cm. | 260,09   |
| MGA34      | 300 x 400 cm. | 348,90   |

## CAJA RÍGIDA



| Referencia | €/unidad |
|------------|----------|
| CAJAMG     | 100,34   |

## MOSTRADOR DE MADERA



| Referencia | €/unidad |
|------------|----------|
| MSM        | 208,60   |

**MARCO ABATIBLE**



| Referencia | Medidas    | Tipo    | €/unidad     |
|------------|------------|---------|--------------|
| YCL5       | 900 x 2000 | 1 Cara  | <b>26,08</b> |
| YCL5D      | 900 x 2000 | 2 Caras | <b>38,22</b> |



**ENROLLABLE CON MOVIMIENTO UNA CARA**



| Referencia | Medidas cm. | Luz | €/unidad      |
|------------|-------------|-----|---------------|
| HK3        | 85 x 200    | NO  | <b>126,34</b> |
| HK3B       | 85 x 200    | SI  | <b>136,86</b> |



**ENROLLABLE CON MOVIMIENTO DOBLE CARA**



| Referencia | Medidas cm. | Luz | €/unidad      |
|------------|-------------|-----|---------------|
| HK4        | 85 x 200    | NO  | <b>141,08</b> |
| HK4B       | 85 x 200    | SI  | <b>185,30</b> |



BANDERA MÓVIL

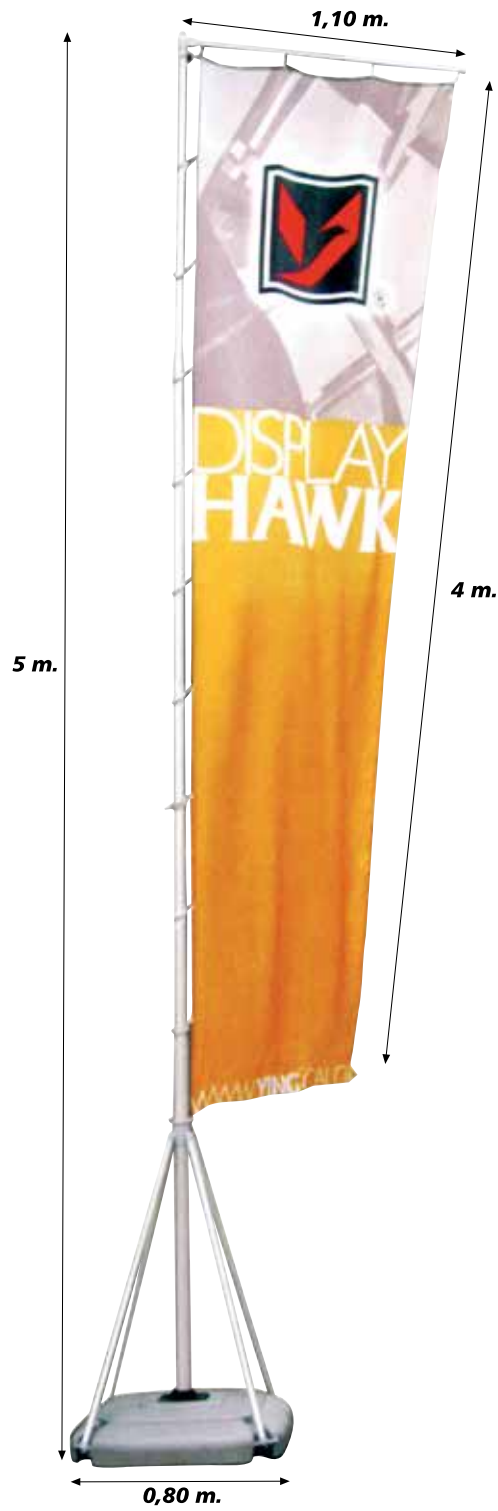

| Referencia | €/unidad |
|------------|----------|
| MBM        | 122,50   |

# apil

C / Einstein, 11  
Pol. Ind. Sur M-50  
28914 Leganés (Madrid)

---

Tel.: 916 418 990  
Fax: 916 435 388

---

www.apil.es  
apil@apil.es

APIL NEÓN S.L. se reserva el derecho de modificar los precios de esta tarifa sin previo aviso, en función de las fluctuaciones del mercado o la variación de las materias primas, por lo que les recomendamos pedirnos presupuesto o consultar nuestra página web [www.apil.es](http://www.apil.es) donde estarán los precios debidamente actualizados.

Recuerda que en caso de detectar daños en el embalaje de tu pedido o alguna anomalía en el proceso de entrega, deberás indicarlo en el campo de "observaciones" del albarán del transportista.